



**Dayflex**<sup>®</sup>  
Corporation

**Adaptadores Hidraulicos**

**SELLOS HIDRAULICOS**
**NORMAS AMERICANAS**

NPTF (30° FLARE)	National Pipe Tapered for Fuel	SAE J516 /J476
NPSM (30° FLARE)	National Pipe Straight thread for Mechanical	J476
NPSF (30° FLARE)	National Pipe Straight thread for Fuels	
JIC (37° FLARE)	Joint Industrial Conference	SAE J514 /J516
SAE (45° FLARE)	Society of Automotive Engineers	
O-RING BOSS		J1926
ORFS	O-Ring Face Seal	SAE J516 /J1453
O-RING FLANGE CODE 61		SAE J518
O-RING FLANGE CODE 62		SAE J518

**NORMAS EUROPEAS**

BSPP (30° FLARE)	British Standard Pipe Parallel	ISO 228
BSPP (30° FLARE) O-RING	British Standard Pipe Parallel	ISO 1179-3
BSPT (30° FLARE)	British Standard Pipe Tapered	ISO 7-PT
GAZ (24° FLARE)		
DIN (24° FLARE) L.T	Deutsche Industrial Norme	DIN 20066 /3865
DIN (24° FLARE) H.T.	Deutsche Industrial Norme	DIN 20066 /3861

**NORMAS JAPONESAS**

JIS (30° FLARE)	Japanese Industrial Standard	JIS B 8363
KOMATSU (30° FLARE)		JIS B 8363

**GUIA DIMENSIONES DE ROSCAS**
**TAMAÑO NOMINAL ROSCA**

GUIÓN	NPT / NPS	BSP / JIS	JIC / BOSS	SAE - 45°	ORFS A. PLANO	CODIGO 61 D. EXT.	CODIGO 62 D. EXT.	DIN SERIE LIGERA	DIN SERIE PESADA	KOMATSU
-2	1/8-27	1/8-28	5/16-24	5/16-24	...	...	...	...	M14*1,5	...
-3	...	...	3/8-24	3/8-24	...	...	...	M12*1,5	M16*1,5	...
-4	1/4-18	1/4-19	7/16-20	7/16-20	9/16-18	...	...	M14*1,5	M18*1,5	M14*1,5
-5	...	...	1/2-20	1/2-20	...	...	...	M16*1,5	M20*1,5	...
-6	3/8-18	3/8-19	9/16-18	5/8-18	11/16-16	...	...	M18*1,5	M22*1,5	M18*1,5
-7	...	...	...	11/16-16	...	...	...	...	...	M22*1,5
-8	1/2-14	1/2-14	3/4-16	3/4-16	13/16-16	30.2	31.7	M22*1,5	M24*1,5	...
-10	...	5/8-14	7/8-14	7/8-14	1-14	34.0	...	M26*1,5	M30*2	M24*1,5
-12	3/4-14	3/4-14	1.1/16-14	1.1/16-14	1.3/16-12	38.1	41.3	M30*1,5	M36*2	M30*1,5
-14	...	...	1.3/16-12	1.1/2-12	...	...	...	...	...	...
-16	1-11,5	1-11	1.5/16-12	1.3/8-12	1.7/16-12	44.4	47.6	M36*2	M42*2	M33*1,5
-20	1.1/4-11,5	1.1/4-11	1.5/8-12	...	1.11/16-12	50.8	53.9	M42*2	M45*2	M36*1,5
-24	1.1/2-11,5	1.1/2-11	1.7/8-12	...	2-12	60.3	63.5	M45*2	M52*2	M42*1,5
-32	2-11,5	2-11	2.1/2-12	...	...	71.4	79.4	M52*2	...	...
-40	...	...	...	...	...	84.1	...	...	...	...
-48	...	...	...	...	...	101.6	...	...	...	...

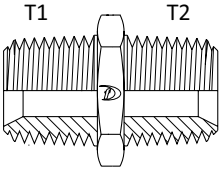
REFERENCIA	PARTE No.	NPTF T1	NPTF T2
<b>D24SA</b> Macho NPTF con Hexagono  	D24SA-02	1/8	1/8
	D24SA-04-02	1/4	1/8
	D24SA-04	1/4	1/4
	D24SA-06-04	3/8	1/4
	D24SA-06	3/8	3/8
	D24SA-08-04	1/2	1/4
	D24SA-08-06	1/2	3/8
	D24SA-08	1/2	1/2
	D24SA-12-08	3/4	1/2
	D24SA-12	3/4	3/4
	D24SA-16-12	1	3/4
	D24SA-16	1	1
	D24SA-20-16	1 1/4	1
	D24SA-20	1 1/4	1 1/4
	D24SA-24	1 1/2	1 1/2
	D24SA-32	2	2

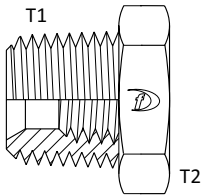
REFERENCIA	PARTE No.	NPTF T1	NPTF T2
<b>D24SB</b> Macho NPTF a Hembra NPTF  	D24SB-04-02	1/4	1/8
	D24SB-06-02	3/8	1/8
	D24SB-06-04	3/8	1/4
	D24SB-08-02	1/2	1/8
	D24SB-08-04	1/2	1/4
	D24SB-08-06	1/2	3/8
	D24SB-12-04	3/4	1/4
	D24SB-12-06	3/4	3/8
	D24SB-12-08	3/4	1/2
	D24SB-16-04	1	1/4
	D24SB-16-06	1	3/8
	D24SB-16-08	1	1/2
	D24SB-16-12	1	3/4
	D24SB-20-08	1 1/4	1/2
	D24SB-20-12	1 1/4	3/4
	D24SB-20-16	1 1/4	1
	D24SB-24-12	1 1/2	3/4
	D24SB-24-16	1 1/2	1
	D24SB-32-16	2	1
	D24SB-32-20	2	1 1/4
	D24SB-32-24	2	1 1/2
	D24SB-32-16	2	1

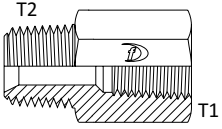
REFERENCIA	PARTE No.	NPTF T1	NPTF T2
<b>D24SG</b> Hembra NPTF a Macho NPTF  	D24SG-04-02	1/4	1/8
	D24SG-06-04	3/8	1/4
	D24SG-08-02	1/2	1/8
	D24SG-08-04	1/2	1/4
	D24SG-08-06	1/2	3/8
	D24SG-12-04	3/4	1/4
	D24SG-12-08	3/4	1/2
	D24SG-16-06	1	3/8
	D24SG-16-08	1	1/2
	D24SG-16-12	1	3/4
	D24SG-20-16	1 1/4	1
	D24SG-24-20	1 1/2	1 1/4
	D24SG-32-24	2	1 1/2

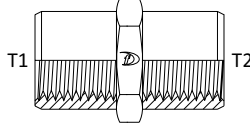
REFERENCIA	PARTE No.	NPTF T1	NPTF T2
<b>D24SJ</b> Unión Hembra NPTF  	D24SJ-02	1/8	1/8
	D24SJ-04	1/4	1/4
	D24SJ-04-02	1/4	1/8
	D24SJ-06	3/8	3/8
	D24SJ-06-04	3/8	1/4
	D24SJ-08	1/2	1/2
	D24SJ-08-06	1/2	3/8
	D24SJ-12	3/4	3/4
	D24SJ-12-08	3/4	1/2
	D24SJ-16	1	1
	D24SJ-20	1 1/4	1 1/4
	D24SJ-24	1 1/2	1 1/2

REFERENCIA	PARTE No.	NPTF T1	
<b>D24SR</b> Tapón Macho NPTF Hexagono Pulg	D24SR-02	1/8	
	D24SR-04	1/4	
	D24SR-06	3/8	
	D24SR-08	1/2	
	D24SR-12	3/4	
	D24SR-16	1	
	D24SR-20	1 1/4	
	D24SR-24	1 1/2	
	D24SR-32	2	

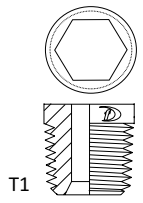

REFERENCIA	PARTE No.	NPTF T1		
<b>D25SP</b> Tapón Macho NPTF Cabeza Cuadrada	D25SP-02	1/8		
	D25SP-04	1/4		
	D25SP-06	3/8		
	D25SP-08	1/2		
	D25SP-12	3/4		
	D25SP-16	1		
	D25SP-20	1 1/4		

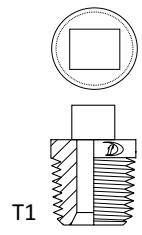

REFERENCIA	PARTE No.	NPTF T1	
<b>D24ST</b> Macho NPTF Cabeza Hexagonal	D24ST-02	1/8	
	D24ST-04	1/4	
	D24ST-06	3/8	
	D24ST-08	1/2	
	D24ST-12	3/4	
	D24ST-16	1	
	D24ST-20	1 1/4	
	D24ST-24	1 1/2	
	D24ST-32	2	

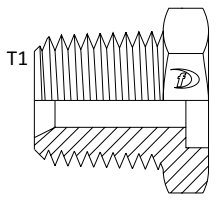

REFERENCIA	PARTE No.	NPTF T1		
<b>D25TG</b> Codo 45° Macho NPTF a Hembra NPTF	D25TG-02	1/8		
	D25TG-04	1/4		
	D25TG-06	3/8		
	D25TG-08	1/2		
	D25TG-12	3/4		
	D25TG-16	1		
	D25TG-20	1 1/4		

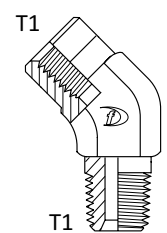

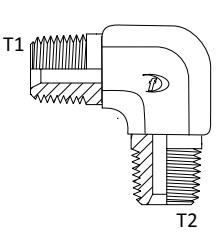

REFERENCIA	PARTE No.	NPTF T1	NPTF T2
<b>D25UA</b> Codo 90° Macho NPTF 	D25UA-02	1/8	1/8
	D25UA-04	1/4	1/4
	D25UA-06-04	3/8	1/4
	D25UA-06	3/8	3/8
	D25UA-08-06	1/2	3/8
	D25UA-08	1/2	1/2
	D25UA-12-08	3/4	1/2
	D25UA-12	3/4	3/4
	D25UA-16	1	1
	D25UA-16-12	1	3/4
	D25UA-20	1 1/4	1 1/4
	D25UA-24	1 1/2	1 1/2

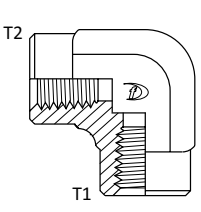
REFERENCIA	PARTE No.	NPTF T1	NPTF T2
<b>D25UG</b> Codo 90° Macho NPTF a Hembra NPTF 	D25UG-02	1/8	1/8
	D25UG-02-04	1/8	1/4
	D25UG-04	1/4	1/4
	D25UG-04-02	1/4	1/8
	D25UG-04-06	1/4	3/8
	D25UG-06	3/8	3/8
	D25UG-06-04	3/8	1/4
	D25UG-06-08	3/8	1/2
	D25UG-08	1/2	1/2
	D25UG-08-06	1/2	3/8
	D25UG-08-12	1/2	3/4
	D25UG-12	3/4	3/4
	D25UG-12-08	3/4	1/2
	D25UG-16	1	1
	D25UG-20	1 1/4	1 1/4
	D25UG-24	1 1/2	1 1/2
	D25UG-32	2	2

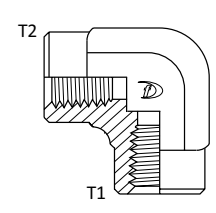
REFERENCIA	PARTE No.	NPTF T1	
<b>D25UJ</b> Codo 90° Hembra NPTF 	D25UJ-02	1/8	
	D25UJ-04	1/4	
	D25UJ-06	3/8	
	D25UJ-08	1/2	
	D25UJ-12	3/4	
	D25UJ-16	1	
	D25UJ-20	1 1/4	
	D25UJ-24	1 1/2	
	D25UJ-32	2	

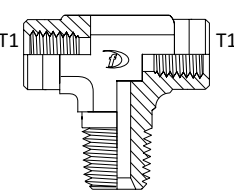
REFERENCIA	PARTE No.	NPTF T1	
<b>D25VC</b> TEE Hembra NPTF - Hembra NPTF a Macho NPTF 	D25VC-02	1/8	
	D25VC-04	1/4	
	D25VC-06	3/8	
	D25VC-08	1/2	
	D25VC-12	3/4	
	D25VC-16	1	
	D25VC-20	1 1/4	
	D25VC-24	1 1/2	
	D25VC-32	2	

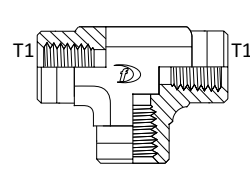
REFERENCIA	PARTE No.	NPTF T1	
<b>D25VJ</b> TEE Hembra NPTF 	D25VJ-02	1/8	
	D25VJ-04	1/4	
	D25VJ-06	3/8	
	D25VJ-08	1/2	
	D25VJ-12	3/4	
	D25VJ-16	1	
	D25VJ-20	1 1/4	
D25VJ-24	1 1/2		

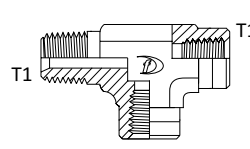
REFERENCIA	PARTE No.	NPTF T1	
<b>D25VK</b> TEE Macho NPTF a Hembra NPTF 	D25VK-02	1/8	
	D25VK-04	1/4	
	D25VK-06	3/8	
	D25VK-08	1/2	
	D25VK-12	3/4	
	D25VK-16	1	
	D25VK-20	1 1/4	
	D25VK-24	1 1/2	
	D25VK-32	2	

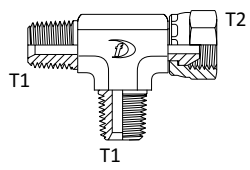
REFERENCIA	PARTE No.	NPTF T1	NPTF T2
<b>D25VT</b> TEE Macho NPTF a Hembra NPTF A Macho NPTF 	D25VT-02	1/8	1/8
	D25VT-04	1/4	1/4
	D25VT-06	3/8	3/8
	D25VT-08	1/2	1/2
	D25VT-12	3/4	3/4

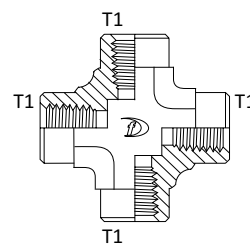
REFERENCIA	PARTE No.	NPTF T1	NPTF T2
<b>D25WJ</b> Cruz Hembra NPTF 	D25WJ-02	1/8	
	D25WJ-04	1/4	
	D25WJ-06	3/8	
	D25WJ-08	1/2	
	D25WJ-12	3/4	
	D25WJ-16	1	

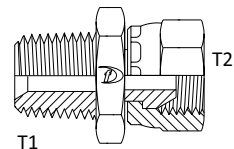
REFERENCIA	PARTE No.	NPTF T1	NPSM T2
<b>D60SA</b> Macho NPTF a Hembra NPSM 	D60SA-02-02	1/8-27	1/8-27
	D60SA-02-04	1/8-27	1/4-18
	D60SA-04-02	1/4-18	1/8-27
	D60SA-04-04	1/4-18	1/4-18
	D60SA-04-06	1/4-18	3/8-18
	D60SA-06-04	3/8-18	1/4-18
	D60SA-06-06	3/8-18	3/8-18
	D60SA-06-08	3/8-18	1/2-14
	D60SA-08-04	1/2-14	1/4-18
	D60SA-08-06	1/2-14	3/8-18
	D60SA-08-08	1/2-14	1/2-14
	D60SA-08-12	1/2-14	3/4-14
	D60SA-12-08	3/4-14	1/2-14
	D60SA-12-12	3/4-14	3/4-14
	D60SA-12-16	3/4-14	1-11 1/2
	D60SA-16-12	1-11 1/2	3/4-14
	D60SA-16-16	1-11 1/2	1-11 1/2
	D60SA-16-20	1-11 1/2	1 1/4-11 1/2
	D60SA-20-16	1 1/4-11 1/2	1-11 1/2
	D60SA-20-20	1 1/4-11 1/2	1 1/4-11 1/2
D60SA-20-24	1 1/4-11 1/2	1 1/2-11 1/2	
D60SA-24-24	1 1/2-11 1/2	1 1/2-11 1/2	
D60SA-32-32	2-11 1/2	2-11 1/2	

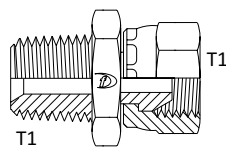
REFERENCIA	PARTE No.	NPTF T1	NPSM T2
<b>D64SA</b> Macho NPTF a Hembra NPSM 	D64SA-04-04	1/4-18	
	D64SA-06-06	3/8-18	
	D64SA-08-08	1/2-14	
	D64SA-12-12	3/4-14	

REFERENCIA	PARTE No.	O-BOSS T1	NPSM T2
<b>D60SB</b> Macho O-RING-BOSS a Hembra NPSM	D60SB-04-02	7/16-20	1/8-27
	D60SB-04-04	7/16-20	1/4-18
	D60SB-05-04	1/2-20	1/4-18
	D60SB-06-04	9/16-18	1/4-18
	D60SB-06-06	9/16-18	3/8-18
	D60SB-06-08	9/16-18	1/2-14
	D60SB-08-04	3/4-16	1/4-18
	D60SB-08-06	3/4-16	3/8-18
	D60SB-08-08	3/4-16	1/2-14
	D60SB-08-12	3/4-16	3/4-14
	D60SB-10-06	7/8-14	3/8-18
	D60SB-10-08	7/8-14	1/2-14
	D60SB-10-12	7/8-14	3/4-14
	D60SB-12-08	1 1/16-12	1/2-14
	D60SB-12-12	1 1/16-12	3/4-14
	D60SB-12-16	1 1/16-12	1-11 1/2
	D60SB-14-12	1 3/16-12	3/4-14
	D60SB-16-12	1 5/16-12	3/4-14
	D60SB-16-16	1 5/16-12	1-11 1/2
	D60SB-16-20	1 5/16-12	1-1/4-11 1/2
	D60SB-20-16	1 5/8-1/2	1-11 1/2
	D60SB-20-20	1 5/8-1/2	1 1/4-11 1/2
	D60SB-24-24	1 7/8-1/2	1 1/2-11 1/2

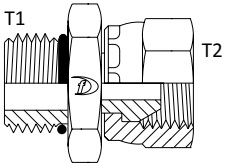

REFERENCIA	PARTE No.	NPTF T1	NPSM T2
<b>D60SG</b> Hembra NPTF a Hembra NPSM	D60SG-02-02	1/8-27	1/8-27
	D60SG-02-04	1/8-27	1/4-18
	D60SG-04-02	1/4-18	1/8-27
	D60SG-04-04	1/4-18	1/4-18
	D60SG-04-08	1/4-18	1/2-14
	D60SG-06-04	3/8-18	1/4-18
	D60SG-06-06	3/8-18	3/8-18
	D60SG-06-08	3/8-18	1/2-14
	D60SG-08-04	1/2-14	1/4-18
	D60SG-08-06	1/2-14	3/8-18
	D60SG-08-08	1/2-14	1/2-14
	D60SG-12-08	3/4-14	1/2-14
	D60SG-12-12	3/4-14	3/4-14
	D60SG-12-16	3/4-14	1-11 1/2
	D60SG-16-12	1-11 1/2	3/4-14
	D60SG-16-16	1-11 1/2	1-11 1/2
	D60SG-20-20	1 1/4-11 1/2	1 1/4-11 1/2
	D60SG-24-24	1 1/2-11 1/2	1 1/2-11 1/2
	D60SG-32-32	2-11 1/2	2-11 1/2

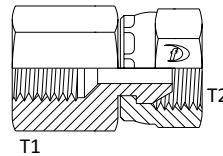

REFERENCIA	PARTE No.	NPTF T1	NPSM T2
<b>D64SG</b> Hembra NPTF a Hembra NPSM Alta presión	D64SG-04-04	1/4-18	1/4-18
	D64SG-06-06	3/8-18	3/8-18
	D64SG-08-08	1/2-14	1/2-14
	D64SG-12-12	3/4-14	3/4-14

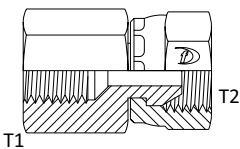

REFERENCIA	PARTE No.	NPTF T1	NPSM T2
<b>D60TA</b> Codo 45° Macho NPTF a Hembra NPSM	D60TA-02-02	1/8-27	1/8-27
	D60TA-04-04	1/4-18	1/4-18
	D60TA-04-06	1/4-18	3/8-18
	D60TA-06-06	3/8-18	3/8-18
	D60TA-06-08	3/8-18	1/2-14
	D60TA-08-04	1/2-14	1/4-18
	D60TA-08-06	1/2-14	3/8-18
	D60TA-08-08	1/2-14	1/2-14
	D60TA-08-12	1/2-14	3/4-14
	D60TA-12-08	3/4-14	1/2-14
	D60TA-12-12	3/4-14	3/4-14
	D60TA-12-16	3/4-14	1-11 1/2
	D60TA-16-12	1-11 1/2	3/4-14
	D60TA-16-16	1-11 1/2	1-11 1/2
	D60TA-16-20	1-11 1/2	1 1/4-11 1/2
	D60TA-20-16	1 1/4-11 1/2	1-11 1/2
	D60TA-20-20	1 1/4-11 1/2	1 1/4-11 1/2
	D60TA-24-24	1 1/2-11 1/2	1 1/2-11 1/2
	D60TA-32-32	2-11 1/2	2-11 1/2

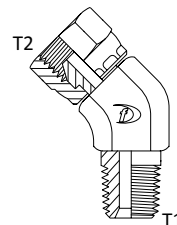

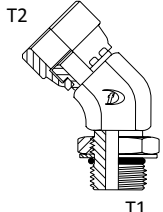
REFERENCIA	PARTE No.	O-BOSS T1	NPSM T2
<b>D60TB</b> Codo 45° Macho O-RING BOSS a Hembra NPSM  	D60TB-04-04	7/16-20	1/4-18
	D60TB-06-04	9/16-18	1/4-18
	D60TB-06-06	9/16-18	3/8-18
	D60TB-06-08	9/16-18	1/2-14
	D60TB-08-06	3/4-16	3/8-18
	D60TB-08-08	3/4-16	1/2-14
	D60TB-08-12	3/4-16	3/4-14
	D60TB-10-04	7/8-14	1/4-18
	D60TB-10-06	7/8-14	3/8-18
	D60TB-10-08	7/8-14	1/2-14
	D60TB-10-12	7/8-14	3/4-14
	D60TB-12-06	1 1/16-12	3/8-18
	D60TB-12-08	1 1/16-12	1/2-14
	D60TB-12-12	1 1/16-12	3/4-14
	D60TB-12-16	1 1/16-12	1-11 1/2
	D60TB-16-12	1 5/16-12	3/4-14
	D60TB-16-16	1 5/16-12	1-11 1/2

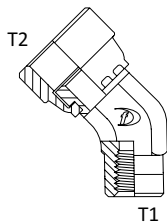
REFERENCIA	PARTE No.	NPTF T1	NPSM T2	
<b>D60TG</b> Codo 45° Hembra NPTF a hembra NPSM  	D60TG-04-04	1/4 - 18	1/4 - 18	
	D60TG-06-06	3/8 - 18	3/8 - 18	
	D60TG-08-06	1/2 - 14	3/8 - 18	
	D60TG-12-08	3/4 - 14	1/2 - 14	
	D60TG-12-12	3/4 - 14	3/4 - 14	
	D60TG-16-12	1-11/12	3/4 - 14	
	D60TG-16-16	1-11/12	1-11/12	
	D60TG-20-20	1 1/4-11 1/2	1 1/4-11 1/2	
	D60TG-24-24	1 1/2-11 1/2	1 1/2-11 1/2	

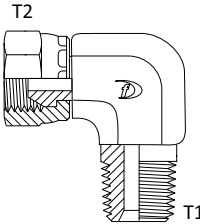
REFERENCIA	PARTE No.	NPTF T1	NPSM T2
<b>D60UA</b> Codo 90° Macho NPTF a Hembra NPSM  	D60UA-02-02	1/8-27	1/8-27
	D60UA-02-04	1/8-27	1/4-18
	D60UA-04-04	1/4-18	1/4-18
	D60UA-04-06	1/4-18	3/8-18
	D60UA-06-04	3/8-18	1/4-18
	D60UA-06-06	3/8-18	3/8-18
	D60UA-06-08	3/8-18	1/2-14
	D60UA-08-04	1/2-14	1/4-18
	D60UA-08-06	1/2-14	3/8-18
	D60UA-08-08	1/2-14	1/2-14
	D60UA-08-12	1/2-14	3/4-14
	D60UA-12-06	3/4-14	3/8-18
	D60UA-12-08	3/4-14	1/2-14
	D60UA-12-12	3/4-14	3/4-14
	D60UA-12-16	3/4-14	1-11 1/2
	D60UA-16-08	1-11 1/2	1/2-14
	D60UA-16-12	1-11 1/2	1-11 1/2
	D60UA-16-16	1-11 1/2	1-11 1/2
	D60UA-16-20	1-11 1/2	1 1/4-11 1/2
	D60UA-20-16	1 1/4-11 1/2	1-11 1/2
D60UA-20-20	1 1/4-11 1/2	1 1/4-11 1/2	
D60UA-20-24	1 1/4-11 1/2	1 1/2-11 1/2	
D60UA-24-24	1 1/2-11 1/2	1 1/2-11 1/2	
D60UA-32-32	2-11 1/2	2-11 1/2	

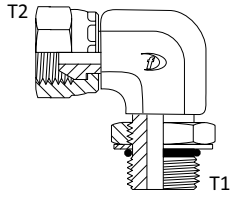
REFERENCIA	PARTE No.	O-BOSS T1	NPSM T2
<b>D60UB</b> Codo 90° Macho O-RING BOSS a Hembra NPSM  	D60UB-04-04	7/16-20	1/4-18
	D60UB-04-06	7/16-20	3/8-18
	D60UB-06-04	9/16-18	1/4-18
	D60UB-06-06	9/16-18	3/8-18
	D60UB-06-08	9/16-18	1/2-14
	D60UB-08-04	3/4-16	1/4-18
	D60UB-08-06	3/4-16	3/8-18
	D60UB-08-08	3/4-16	1/2-14
	D60UB-08-12	3/4-16	3/4-14
	D60UB-10-06	7/8-14	3/8-18
	D60UB-10-08	7/8-14	1/2-14
	D60UB-10-12	7/8-14	3/4-14
	D60UB-12-08	1 1/16-12	1/2-14
	D60UB-12-12	1 1/16-12	3/4-14
	D60UB-12-16	1 1/16-12	1-11 1/2
	D60UB-14-12	1 3/16-12	3/4-14
	D60UB-16-12	1 5/16-12	3/4-14
	D60UB-16-16	1 5/16-12	1-11 1/2
D60UB-16-20	1 5/16-12	1 1/4-11 1/2	
D60UB-20-20	1 5/8-12	1 1/4-11 1/2	
D60UB-24-24	1 7/8-12	1 1/2-11 1/2	



REFERENCIA	PARTE No.	NPTF T1	NPSM T2
<b>D60UC</b> Codo 90° Largo Macho NPTF a Hembra NPSM	D60UC-02-02	1/8-27	1/8-27
	D60UC-04-04	1/4-18	1/4-18
	D60UC-06-06	3/8-18	3/8-18
	D60UC-06-08	3/8-18	1/2-14
	D60UC-08-08	1/2-14	1/2-14
	D60UC-12-12	3/4-14	3/4-14
	D60UC-16-16	1-11 1/2	1-11 1/2

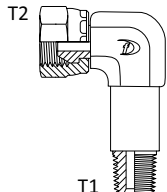

REFERENCIA	PARTE No.	O-BOSS T1	NPSM T2
<b>D60UD</b> Codo 90° Largo Macho O-RING BOSS a Hembra NPSM	D60UD-04-04	7/16-20	1/4-18
	D60UD-06-06	9/16-18	3/8-18
	D60UD-08-06	3/4-16	3/8-18
	D60UD-08-08	3/4-16	1/2-14
	D60UD-10-08	7/8-14	1/2-14
	D60UD-10-12	7/8-14	3/4-14
	D60UD-12-12	1 1/16-12	3/4-14

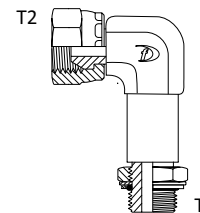

REFERENCIA	PARTE No.	NPTF T1	NPSM T2
<b>D60UG</b> Codo 90° Hembra NPTF a Hembra NPSM	D60UG-02-02	1/8-27	1/8-27
	D60UG-04-04	1/4-18	1/4-18
	D60UG-06-04	3/8-18	1/4-18
	D60UG-06-06	3/8-18	3/8-18
	D60UG-08-06	1/2-14	3/8-18
	D60UG-08-08	1/2-14	1/2-14
	D60UG-12-12	3/4-14	3/4-14
	D60UG-16-12	1-11 1/2	3/4-14
	D60UG-16-16	1-11 1/2	1-11 1/2
	D60UG-20-20	1 1/4-11 1/2	1 1/4-11 1/2
D60UG-24-24	1 1/2-11 1/2	1 1/2-11 1/2	

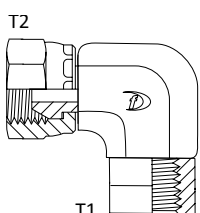

REFERENCIA	PARTE No.	NPTF T1	NPSM T2
<b>D60VC</b> Tee Macho NPTF a Hembra NPSM a Hembra NPSM	D60VC-04-04	1/4 - 18	1/4 - 18
	D60VC-06-06	3/8 - 18	3/8 - 18
	D60VC-06-08	3/8 - 18	1/2 - 14
	D60VC-08-06	1/2 - 14	3/8 - 18
	D60VC-08-08	1/2 - 14	1/2 - 14
	D60VC-12-08	3/4 - 14	1/2 - 14
	D60VC-12-12	3/4 - 14	3/4 - 14
	D60VC-16-16	1-11 1/2	1-11 1/2

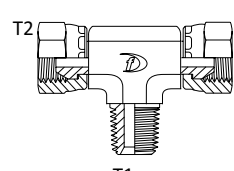

REFERENCIA	PARTE No.	NPTF T1	NPSM T2
<b>D60VH</b> Tee Hembra NPTF a Hembra NPSM - Hembra NPSM	D60VH-04-04	1/4-18	1/4-18
	D60VH-06-06	3/8-18	3/8-18
	D60VH-08-06	1/2-14	3/8-18
	D60VH-08-08	1/2-14	1/2-14
	D60VH-12-08	3/4-14	1/2-14
	D60VH-12-12	3/4-14	3/4-14
	D60VH-16-16	1-11 1/2	1-11 1/2

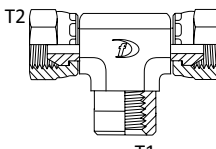

REFERENCIA	PARTE No.	NPSM T1	NPSM T2
<b>D60VJ</b> Tee Hembra NPSM	D60VJ-02	1/8-27	
	D60VJ-04	1/4-18	
	D60VJ-06	3/8-18	
	D60VJ-08	1/2-14	
	D60VJ-12	3/4-14	

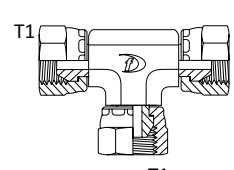

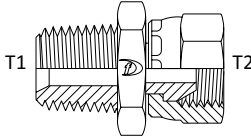
REFERENCIA	PARTE No.	NPTF T1	NPSM T2
<b>D61SA</b> Macho NPTF a Hembra NPSM  	D61SA-04-04-000	1/4-18	1/4-18
	D61SA-04-04-014	1/4-18	1/4-18
	D61SA-04-04-015	1/4-18	1/4-18
	D61SA-04-04-016	1/4-18	1/4-18
	D61SA-04-04-020	1/4-18	1/4-18
	D61SA-04-04-026	1/4-18	1/4-18
	D61SA-04-04-031	1/4-18	1/4-18
	D61SA-04-04-035	1/4-18	1/4-18
	D61SA-04-04-040	1/4-18	1/4-18
	D61SA-04-04-046	1/4-18	1/4-18
	D61SA-04-04-049	1/4-18	1/4-18
	D61SA-04-04-052	1/4-18	1/4-18
	D61SA-04-04-055	1/4-18	1/4-18
	D61SA-04-04-060	1/4-18	1/4-18
	D61SA-04-04-062	1/4-18	1/4-18
	D61SA-04-04-078	1/4-18	1/4-18
	D61SA-04-04-094	1/4-18	1/4-18
	D61SA-04-04-104	1/4-18	1/4-18
	D61SA-04-04-125	1/4-18	1/4-18
	D61SA-04-04-156	1/4-18	1/4-18
	D61SA-04-04-170	1/4-18	1/4-18
	D61SA-06-06-000	3/8-18	3/8-18
	D61SA-06-06-031	3/8-18	3/8-18
	D61SA-06-06-040	3/8-18	3/8-18
	D61SA-06-06-052	3/8-18	3/8-18
	D61SA-06-06-062	3/8-18	3/8-18
	D61SA-06-06-078	3/8-18	3/8-18
	D61SA-06-06-140	3/8-18	3/8-18
	D61SA-08-08-000	1/2-14	1/2-14
	D61SA-08-08-031	1/2-14	1/2-14
	D61SA-08-08-035	1/2-14	1/2-14
	D61SA-08-08-042	1/2-14	1/2-14
	D61SA-08-08-047	1/2-14	1/2-14
	D61SA-08-08-052	1/2-14	1/2-14
	D61SA-08-08-062	1/2-14	1/2-14
	D61SA-08-08-076	1/2-14	1/2-14
	D61SA-08-08-078	1/2-14	1/2-14
	D61SA-08-08-081	1/2-14	1/2-14
	D61SA-08-08-089	1/2-14	1/2-14
	D61SA-08-08-094	1/2-14	1/2-14
	D61SA-08-08-104	1/2-14	1/2-14
	D61SA-08-08-125	1/2-14	1/2-14
	D61SA-08-08-250	1/2-14	1/2-14
	D61SA-08-08-394	1/2-14	1/2-14

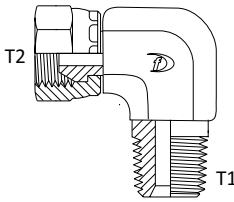
REFERENCIA	PARTE No.	NPTF T1	NPSM T2
<b>D61UA</b> Codo 90° Macho NPTF a Hembra NPSM  	D61UA-04-04-000	1/4-18	1/4-18
	D61UA-04-04-031	1/4-18	1/4-18
	D61UA-04-04-040	1/4-18	1/4-18
	D61UA-04-04-052	1/4-18	1/4-18
	D61UA-04-04-062	1/4-18	1/4-18
	D61UA-04-04-098	1/4-18	1/4-18
	D61UA-04-04-113	1/4-18	1/4-18
	D61UA-06-06-000	3/8-18	3/8-18
	D61UA-06-06-031	3/8-18	3/8-18
	D61UA-06-06-040	3/8-18	3/8-18
	D61UA-06-06-062	3/8-18	3/8-18
	D61UA-06-06-078	3/8-18	3/8-18
	D61UA-06-06-094	3/8-18	3/8-18
	D61UA-06-06-125	3/8-18	3/8-18
	D61UA-08-08-000	1/2-14	1/2-14
	D61UA-08-08-046	1/2-14	1/2-14
	D61UA-08-08-060	1/2-14	1/2-14

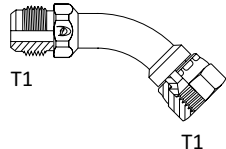
REFERENCIA	PARTE No.	JIC T1	JIC T2
<b>D63TA</b> Codo 45° Macho JIC - Hembra JIC  	D63TA-04-04	7/16-20	
	D63TA-05-05	1/2-20	
	D63TA-06-06	9/16-18	
	D63TA-08-08	3/4-16	
	D63TA-10-10	7/8-14	
	D63TA-12-12	1 1/16-12	
	D63TA-16-16	1 5/16-12	

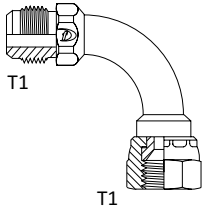
REFERENCIA	PARTE No.	JIC T1	JIC T2
<b>D63UA</b> Codo 90° Macho JIC a Hembra JIC 	D63UA-04-04	7/16-20	
	D63UA-05-05	1/2-20	
	D63UA-06-06	9/16-18	
	D63UA-08-08	3/4-16	
	D63UA-10-10	7/8-14	
	D63UA-12-12	1 1/16-12	
	D63UA-16-16	1 5/16-12	
	D63UA-20-20	1 5/8-12	

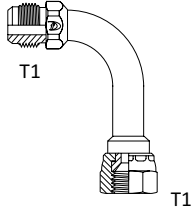
REFERENCIA	PARTE No.	JIC T1	JIC T2
<b>D63UC</b> Codo 90° Macho JIC a Hembra JIC 	D63UC-04-04	7/16-20	
	D63UC-05-05	1/2-20	
	D63UC-06-06	9/16-18	
	D63UC-08-08	3/4-16	
	D63UC-10-10	7/8-14	
	D63UC-12-12	1 1/16-12	
	D63UC-16-16	1 5/16-12	
	D63UC-20-20	1 5/8-12	

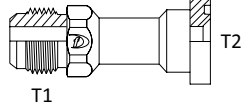
REFERENCIA	PARTE No.	JIC T1	BRIDA T2
<b>D63SB</b> Macho JIC a Brida Código 61 - R2 	D63SB-08-08	3/4-16	1.19
	D63SB-08-12	3/4-16	1.50
	D63SB-12-12	1 1/16-12	1.50
	D63SB-12-16	1 1/16-12	1.75
	D63SB-16-16	1 5/16-12	1.75
	D63SB-16-20	1 5/16-12	2.00
	D63SB-20-20	1 5/8-12	2.00
	D63SB-20-24	1 5/8-12	2.37
	D63SB-24-20	1 7/8-12	2.00
	D63SB-24-24	1 7/8-12	2.37
	D63SB-32-32	2 1/2-12	2.81

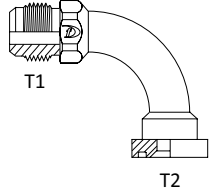
REFERENCIA	PARTE No.	JIC T1	BRIDA T2
<b>D63UB</b> Codo 90° Macho JIC a Brida Código 61 - R2 	D63UB-08-08	3/4-16	1.19
	D63UB-08-12	3/4-16	1.50
	D63UB-12-12	1 1/16-12	1.50
	D63UB-12-16	1 1/16-12	1.75
	D63UB-16-16	1 5/16-12	1.75
	D63UB-16-20	1 5/16-12	2.00
	D63UB-16-24	1 5/16-12	2.37
	D63UB-20-16	1 5/8-12	1.75
	D63UB-20-20	1 5/8-12	2.00
	D63UB-20-24	1 5/8-12	2.37
	D63UB-24-24	1 7/8-12	2.37
D63UB-32-32	2 1/2-12	2.81	

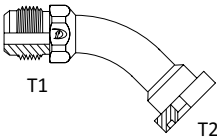
REFERENCIA	PARTE No.	JIC T1	BRIDA T2
<b>D63TB</b> Codo 45° Macho JIC a Brida Código: 61 - R2 	D63TB-08-08	3/4-16	1.19
	D63TB-12-12	1 1/16-12	1.50
	D63TB-12-16	1 1/16-12	1.75
	D63TB-16-16	1 5/16-12	1.75
	D63TB-16-20	1 5/16-12	2.00
	D63TB-20-20	1 5/8-12	2.00
	D63TB-20-24	1 5/8-12	2.37
	D63TB-24-24	1 7/8-12	2.37
	D63TB-32-32	2 1/2-12	2.81

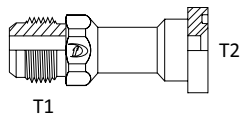
REFERENCIA	PARTE No.	JIC T1	BRIDA T2
<b>D63SE</b> Macho JIC a Brida Código 61 	D63SE-12-12	1 1/16-12	1.50
	D63SE-12-16	1 1/16-12	1.75
	D63SE-16-16	1 5/16-12	1.75
	D63SE-16-20	1 5/16-12	2.00
	D63SE-20-20	1 5/8-12	2.00
	D63SE-20-24	1 5/8-12	2.37
	D63SE-24-24	1 7/8-12	2.37
	D63SE-32-32	2 1/2-12	2.81

REFERENCIA	PARTE No.	JIC T1	BRIDA T2
<b>D63TE</b> Codo 45° Macho JIC a Brida Código: 61	D63TE-12-12	1 1/16-12	1.50
	D63TE-12-16	1 1/16-12	1.75
	D63TE-16-16	1 5/16-12	1.75
	D63TE-16-20	1 5/16-12	2.00
	D63TE-20-20	1 5/8-12	2.00
	D63TE-20-24	1 5/8-12	2.37
	D63TE-24-24	1 7/8-12	2.37
	D63TE-32-32	2 1/2-12	2.81

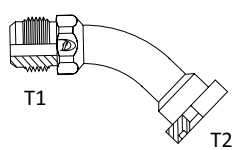

REFERENCIA	PARTE No.	JIC T1	BRIDA T2
<b>D63UE</b> Codo 90° macho JIC a Brida Código 61	D63UE-12-12	1 1/16-12	1.50
	D63UE-12-16	1 1/16-12	1.75
	D63UE-16-16	1 5/16-12	1.75
	D63UE-16-20	1 5/16-12	2.00
	D63UE-20-20	1 5/8-12	2.00
	D63UE-20-24	1 5/8-12	2.37
	D63UE-24-24	1 7/8-12	2.37
	D63UE-32-32	2 1/2-12	2.81

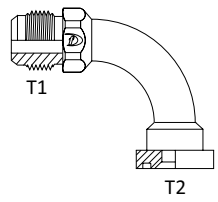

REFERENCIA	PARTE No.	JIC T1	BRIDA T2
<b>D63SF</b> Macho JIC a Brida Código: 62	D63SF-12-12	1 1/16-12	1.62
	D63SF-12-16	1 1/16-12	1.87
	D63SF-16-16	1 5/16-12	1.87
	D63SF-16-20	1 5/16-12	2.12
	D63SF-20-20	1 5/8-12	2.12
	D63SF-20-24	1 5/8-12	2.50
	D63SF-24-24	1 7/8-12	2.50
	D63SF-32-32	2 1/2-12	3.12

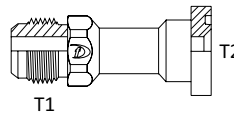

REFERENCIA	PARTE No.	JIC T1	BRIDA T2
<b>D63TF</b> Codo 45° Macho JIC a Brida Código 62	D63TF-12-12	1 1/16-12	1.62
	D63TF-12-16	1 1/16-12	1.87
	D63TF-16-16	1 5/16-12	1.87
	D63TF-16-20	1 5/16-12	2.12
	D63TF-20-20	1 5/8-12	2.12
	D63TF-20-24	1 5/8-12	2.50
	D63TF-24-24	1 7/8-12	2.50
	D63TF-32-32	2 1/2-12	3.12

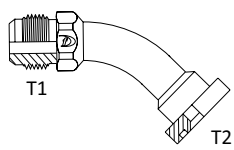

REFERENCIA	PARTE No.	JIC T1	BRIDA T2
<b>D63UF</b> Codo 90° Macho JIC a Brida Código: 62	D63UF-12-12	1 1/16-12	1.62
	D63UF-12-16	1 1/16-12	1.87
	D63UF-16-12	1 5/16-12	1.62
	D63UF-16-16	1 5/16-12	1.87
	D63UF-16-20	1 5/16-12	2.12
	D63UF-20-12	1 5/8-12	1.62
	D63UF-20-20	1 5/8-12	2.12
	D63UF-20-24	1 5/8-12	2.50
	D63UF-24-24	1 7/8-12	2.50
	D63UF-32-32	2 1/2-12	3.12

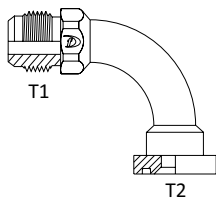



REFERENCIA	PARTE No.	O-BOSS T1	O-BOSS T2
<b>D719-FSO</b> Macho O-RING BOSS - Hembra O-RING BOSS	D719-FSO-04-06	7/16-20	9/16-18
	D719-FSO-06-04	9/16-18	7/16-20
	D719-FSO-06-08	9/16-18	3/4-16
	D719-FSO-08-04	3/4-16	7/16-20
	D719-FSO-08-06	3/4-16	9/16-18
	D719-FSO-08-10	3/4-16	7/8-14
	D719-FSO-08-12	3/4-16	1 1/16-12
	D719-FSO-10-04	7/8-14	7/16-20
	D719-FSO-10-06	7/8-14	9/16-18
	D719-FSO-10-08	7/8-14	3/4-16
	D719-FSO-10-12	7/8-14	1 1/16-12
	D719-FSO-12-04	1 1/16-12	7/16-20
	D719-FSO-12-06	1 1/16-12	9/16-18
	D719-FSO-12-08	1 1/16-12	3/4-16
	D719-FSO-12-10	1 1/16-12	7/8-14
	D719-FSO-12-16	1 1/16-12	1 5/16-12
	D719-FSO-14-04	1 3/16-12	7/16-20
	D719-FSO-14-05	1 3/16-12	1/2-20
	D719-FSO-14-06	1 3/16-12	9/16-18
	D719-FSO-14-12	1 3/16-12	1 1/16-12
	D719-FSO-16-04	1 5/16-12	7/16-20
	D719-FSO-16-05	1 5/16-12	1/2-20
	D719-FSO-16-06	1 5/16-12	9/16-18
	D719-FSO-16-08	1 5/16-12	3/4-16
	D719-FSO-16-10	1 5/16-12	7/8-14
	D719-FSO-16-12	1 5/16-12	1 1/16-12
	D719-FSO-16-20	1 5/16-12	1 5/8-12
	D719-FSO-20-08	1 5/8-12	3/4-16
	D719-FSO-20-10	1 5/8-12	7/8-14
	D719-FSO-20-12	1 5/8-12	1 1/16-12
	D719-FSO-20-16	1 5/8-12	1 5/16-12
	D719-FSO-24-06	1 7/8-12	9/16-18
	D719-FSO-24-12	1 7/8-12	1 1/16-12
D719-FSO-24-16	1 7/8-12	1 5/16-12	
D719-FSO-24-20	1 7/8-12	1 5/8-12	
D719-FSO-32-24	2 1/2-12	1 7/8-12	

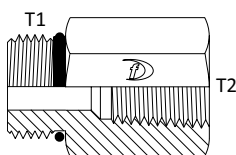

REFERENCIA	PARTE No.	O-BOSS T1	NPTF T2
<b>D720-FSO</b> Macho O-RING BOSS - Hembra NPTF	D720-FSO-04-02	7/16-20	1/8
	D720-FSO-04-04	7/16-20	1/4
	D720-FSO-04-06	7/16-20	3/8
	D720-FSO-05-02	1/2-20	1/8
	D720-FSO-05-04	1/2-20	1/4
	D720-FSO-06-04	9/16-18	1/4
	D720-FSO-06-06	9/16-18	3/8
	D720-FSO-08-04	3/4-16	1/4
	D720-FSO-08-06	3/4-16	3/8
	D720-FSO-08-08	3/4-16	1/2
	D720-FSO-10-04	7/8-14	1/4
	D720-FSO-10-06	7/8-14	3/8
	D720-FSO-10-08	7/8-14	1/2
	D720-FSO-10-12	7/8-14	3/4
	D720-FSO-12-06	1 1/16-12	3/8
	D720-FSO-12-08	1 1/16-12	1/2
	D720-FSO-12-12	1 1/16-12	3/4
	D720-FSO-14-12	1 3/16-12	3/4
	D720-FSO-14-16	1 3/16-12	1
	D720-FSO-16-08	1 5/16-12	1/2
	D720-FSO-16-12	1 5/16-12	3/4
	D720-FSO-16-16	1 5/16-12	1
	D720-FSO-20-16	1 5/8-12	1
	D720-FSO-20-20	1 5/8-12	1 1/4
	D720-FSO-20-24	1 5/8-12	1 1/2
	D720-FSO-24-16	1 7/8-12	1
	D720-FSO-24-20	1 7/8-12	1 1/4
	D720-FSO-24-24	1 7/8-12	1 1/2
	D720-FSO-32-32	2 1/2-12	2

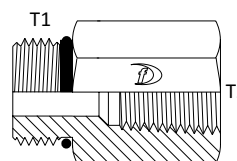

REFERENCIA	PARTE No.	O-BOSS T1	
<b>D721-FSO</b> Tapón Macho O-RING BOSS	D721-FSO-03	3/8-24	
	D721-FSO-04	7/16-20	
	D721-FSO-05	1/2-20	
	D721-FSO-06	9/16-18	
	D721-FSO-08	3/4-16	
	D721-FSO-10	7/8-14	
	D721-FSO-12	1 1/16-12	
	D721-FSO-14	1 3/16-12	
	D721-FSO-16	1 5/16-12	
	D721-FSO-20	1 5/8-12	
	D721-FSO-24	1 7/8-12	
	D721-FSO-32	2 1/2-12	

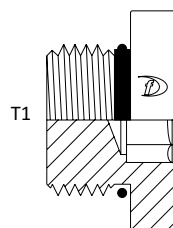



REFERENCIA	PARTE No.	JIC T1	JIC T2
<b>D832-FS</b> Pasamuro Macho JIC a Macho JIC	D832-FS-02	5/16-24	
	D832-FS-03	3/8-24	
	D832-FS-04	7/16-20	
	D832-FS-05	1/2-20	
	D832-FS-06	9/16-18	
	D832-FS-08	3/4-16	
	D832-FS-10	7/8-14	
	D832-FS-12	1 1/16-12	
	D832-FS-16	1 5/16-12	
	D832-FS-20	1 5/8-12	
	D832-FS-24	1 7/8-12	
	D832-FS-32	2 1/2-12	

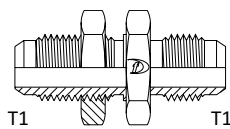

REFERENCIA	PARTE No.	JIC T1	NPTF T2	
<b>D833-FS</b> Codo 90° Macho JIC a Macho NPTF	D833-FS-04-04	7/16-20	1/4	
	D833-FS-06-06	9/16-18	3/8	
	D833-FS-08-06	3/4-16	3/8	
	D833-FS-08-08	3/4-16	1/2	
	D833-FS-10-08	7/8-14	1/2	

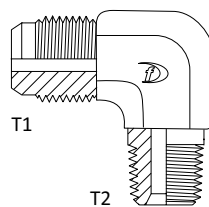

REFERENCIA	PARTE No.	JIC T1	O-BOSS T2
<b>D833-FSO</b> Codo 90° Macho JIC a Macho O-RING BOSS	D833-FSO-06-06	9/16-18	9/16-18
	D833-FSO-08-08	3/4-16	3/4-16
	D833-FSO-10-10	7/8-14	7/8-14

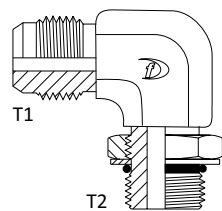

REFERENCIA	PARTE No.	JIC T1	
<b>D839-FS</b> Tapon Macho JIC	D839-FS-02	5/16-24	
	D839-FS-03	3/8-24	
	D839-FS-04	7/16-20	
	D839-FS-05	1/2-20	
	D839-FS-06	9/16-18	
	D839-FS-08	3/4-16	
	D839-FS-10	7/8-14	
	D839-FS-12	1 1/16-12	
	D839-FS-14	1 3/16-12	
	D839-FS-16	1 5/16-12	
	D839-FS-20	1 5/8-12	
	D839-FS-24	1 7/8-12	
	D839-FS-32	2 1/2-12	

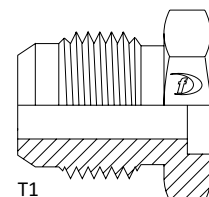

REFERENCIA	PARTE No.	JIC T1	
<b>D841-FS</b> Tapon Hembra JIC	D841-FS-02	5/16-24	
	D841-FS-03	3/8-24	
	D841-FS-04	7/16-20	
	D841-FS-05	1/2-20	
	D841-FS-06	9/16-18	
	D841-FS-08	3/4-16	
	D841-FS-10	7/8-14	
	D841-FS-12	1 1/16-12	
	D841-FS-14	1 3/16-12	
	D841-FS-16	1 5/16-12	
	D841-FS-20	1 5/8-12	
	D841-FS-24	1 7/8-12	
	D841-FS-32	2 1/2-12	

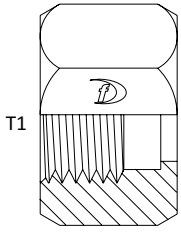

REFERENCIA	PARTE No.	JIC T1	JIC T2
<b>D842-FS</b> Macho JIC - Macho JIC	D842-FS-02	5/16-24	5/16-24
	D842-FS-03	3/8-24	3/8-24
	D842-FS-04	7/16-20	7/16-20
	D842-FS-05	1/2-20	1/2-20
	D842-FS-06-04	9/16-18	7/16-20
	D842-FS-06	9/16-18	9/16-18
	D842-FS-08-06	3/4-16	9/16-18
	D842-FS-08	3/4-16	3/4-16
	D842-FS-10-06	7/8-14	9/16-18
	D842-FS-10-08	7/8-14	3/4-16
	D842-FS-10	7/8-14	7/8-14
	D842-FS-12-08	1 1/16-12	3/4-16
	D842-FS-12-10	1 1/16-12	7/8-14
	D842-FS-12	1 1/16-12	1 1/16-12
	D842-FS-14	1 3/16-12	1 3/16-12
	D842-FS-16-12	1 5/16-12	1 1/16-12
	D842-FS-16	1 5/16-12	1 5/16-12
	D842-FS-20-16	1 5/8-12	1 5/16-12
	D842-FS-20	1 5/8-12	1 5/8-12
	D842-FS-24	1 7/8-12	1 7/8-12
	D842-FS-32	2 1/2-12	2 1/2-12

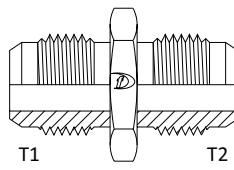

REFERENCIA	PARTE No.	JIC T1	
<b>D842H-FS</b> Macho JIC - Macho JIC Hexagono Largo	D842H-FS-02	5/16-24	
	D842H-FS-03	3/8-24	
	D842H-FS-04	7/16-20	
	D842H-FS-05	1/2-20	
	D842H-FS-06	9/16-18	
	D842H-FS-08	3/4-16	
	D842H-FS-10	7/8-14	
	D842H-FS-12	1 1/16-12	
	D842H-FS-14	1 3/16-12	
	D842H-FS-16	1 5/16-12	
	D842H-FS-20	1 5/8-12	
	D842H-FS-24	1 7/8-12	
	D842H-FS-32	2 1/2-12	

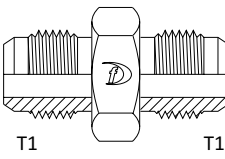

REFERENCIA	PARTE No.	JIC T1	
<b>D842L-FS</b> Macho JIC a Macho JIC Hexagono XLargo	D842L-FS-03	3/8-24	
	D842L-FS-04	7/16-20	
	D842L-FS-05	1/2-20	
	D842L-FS-06	9/16-18	
	D842L-FS-08	3/4-16	
	D842L-FS-10	7/8-14	
	D842L-FS-12	1 1/16-12	
	D842L-FS-16	1 5/16-12	
	D842L-FS-20	1 5/8-12	
	D842L-FS-24	1 7/8-12	
	D842L-FS-32	2 1/2-12	

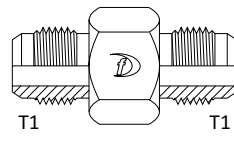



REFERENCIA	PARTE No.	JIC T1	JIC T2
<b>D844-FS</b> TEE Macho JIC	D844-FS-02	5/16-24	5/16-24
	D844-FS-03	3/8-24	3/8-24
	D844-FS-04	7/16-20	7/16-20
	D844-FS-05	1/2-20	1/2-20
	D844-FS-06	9/16-18	9/16-18
	D844-FS-06-06-08	9/16-18	3/4-16
	D844-FS-06-06-10	9/16-18	7/8-14
	D844-FS-08	3/4-16	3/4-16
	D844-FS-10	7/8-14	7/8-14
	D844-FS-10-10-08	7/8-14	3/4-16
	D844-FS-12	1 1/16-12	1 1/16-12
	D844-FS-14	1 3/16-12	1 3/16-12
	D844-FS-16	1 5/16-12	1 5/16-12
	D844-FS-16-16-12	1 5/16-12	1 1/16-12
	D844-FS-20	1 5/8-12	1 5/8-12
	D844-FS-20-16-16	1 5/8-12	1 5/16-12
	D844-FS-24	1 7/8-12	1 7/8-12
D844-FS-32	2 1/2-12	2 1/2-12	

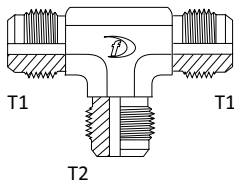

REFERENCIA	PARTE No.	JIC T1	NPTF T2
<b>D845-FS</b> TEE Macho JIC - Macho JIC a Macho NPTF	D845-FS-02-02	5/16-24	1/8
	D845-FS-03-02	3/8-24	1/8
	D845-FS-04-02	7/8-20	1/8
	D845-FS-04-04	7/16-20	1/4
	D845-FS-05-02	1/2-20	1/8
	D845-FS-06-04	9/16-18	1/4
	D845-FS-08-06	3/4-16	3/8
	D845-FS-08-08	3/4-16	1/2
	D845-FS-10-08	7/8-14	1/2
	D845-FS-12-08	1 1/16-12	1/2
	D845-FS-12-12	1 1/16-12	3/4
	D845-FS-14-12	1 3/16-12	3/4
	D845-FS-16-16	1 5/16-12	1
	D845-FS-20-20	1 5/8-12	1 1/4
	D845-FS-24-24	1 7/8-12	1 1/2
	D845-FS-32-32	2 1/2-12	2

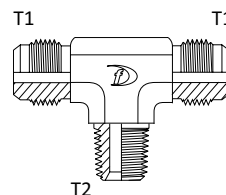

REFERENCIA	PARTE No.	JIC T1	O-BOSS T2
<b>D845-FSO</b> TEE Macho JIC - Macho JIC - Macho O-RING BOSS	D845-FSO-04-04	7/16-20	7/16-20
	D845-FSO-05-05	1/2-20	1/2-20
	D845-FSO-06-06	9/16-18	9/16-18
	D845-FSO-08-08	3/4-16	3/4-16
	D845-FSO-08-08-06	3/4-16	9/16-18
	D845-FSO-10-08	7/8-14	3/4-16
	D845-FSO-10-10	7/8-14	7/8-14
	D845-FSO-12-10	1 1/16-12	7/8-14
	D845-FSO-12-12	1 1/16-12	1 1/16-12
	D845-FSO-12-16	1 1/16-12	1 5/16-12
	D845-FSO-16-16	1 5/16-12	1 5/16-12
	D845-FSO-20-20	1 5/8-12	1 5/8-12
D845-FSO-20-20-24	1 5/8-12	1 7/8-12	
D845-FSO-24-24	1 7/8-12	1 7/8-12	

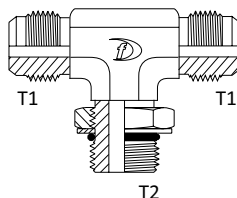

REFERENCIA	PARTE No.	JIC T1	NPTF T2
<b>D846-FS</b> Macho JIC a Hembra NPTF	D846-FS-02-02	5/16-24	1/8
	D846-FS-03-02	3/8-24	1/8
	D846-FS-04-02	7/16-20	1/8
	D846-FS-04-04	7/16-20	1/4
	D846-FS-04-08	7/16-20	1/2
	D846-FS-05-02	1/2-20	1/8
	D846-FS-05-04	1/2-20	1/4
	D846-FS-06-04	9/16-18	1/4
	D846-FS-06-06	9/16-18	3/8
	D846-FS-06-08	9/16-18	1/2
	D846-FS-08-06	3/4-16	3/8
	D846-FS-08-08	3/4-16	1/2
	D846-FS-10-06	7/8-14	3/8
	D846-FS-10-08	7/8-14	1/2
	D846-FS-10-12	7/8-14	3/4
	D846-FS-12-08	1 1/16-12	1/2
	D846-FS-12-12	1 1/16-12	3/4
	D846-FS-14-12	1 3/16-12	3/4
	D846-FS-16-12	1 5/16-12	3/4
	D846-FS-16-16	1 5/16-12	1
D846-FS-20-20	1 5/8-12	1 1/4	
D846-FS-24-24	1 7/8-12	1 1/2	
D846-FS-32-32	2 1/2-12	2	

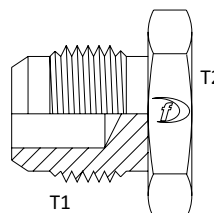

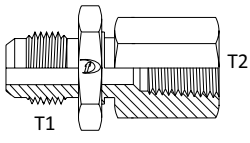
REFERENCIA	PARTE No.	JIC T1	NPTF T2
<b>D847-FS</b> Macho JIC con Tuerca - Hembra NPTF 	D847-FS-04-02	7/16-20	1/8
	D847-FS-04-04	7/16-20	1/4
	D847-FS-06-06	9/16-18	3/8
	D847-FS-08-06	3/4-16	3/8
	D847-FS-08-08	3/4-16	1/2
	D847-FS-10-08	7/8-14	1/2
	D847-FS-12-12	1 1/16-12	3/4
	D847-FS-16-16	1 5/16-12	1

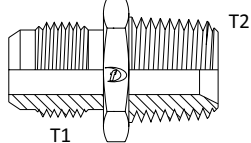
REFERENCIA	PARTE No.	JIC T1	NPTF T2
<b>D848-FS</b> Macho JIC a Macho NPTF 	D848-FS-02-02	5/16-24	1/8
	D848-FS-03-02	3/8-24	1/8
	D848-FS-04-02	7/16-20	1/8
	D848-FS-04-04	7/16-20	1/4
	D848-FS-04-06	7/16-20	3/8
	D848-FS-04-08	7/16-20	1/2
	D848-FS-05-02	1/2-20	1/8
	D848-FS-05-04	1/2-20	1/4
	D848-FS-05-06	1/2-20	3/8
	D848-FS-06-02	9/16-18	1/8
	D848-FS-06-04	9/16-18	1/4
	D848-FS-06-06	9/16-18	3/8
	D848-FS-06-08	9/16-18	1/2
	D848-FS-06-12	9/16-18	3/4
	D848-FS-08-04	3/4-16	1/4
	D848-FS-08-06	3/4-16	3/8
	D848-FS-08-08	3/4-16	1/2
	D848-FS-08-12	3/4-16	3/4
	D848-FS-08-16	3/4-16	1
	D848-FS-10-06	7/8-14	3/8
	D848-FS-10-08	7/8-14	1/2
	D848-FS-10-12	7/8-14	3/4
	D848-FS-12-02	1 1/16-12	1/8
	D848-FS-12-06	1 1/16-12	3/8
	D848-FS-12-08	1 1/16-12	1/2
	D848-FS-12-12	1 1/16-12	3/4
	D848-FS-12-16	1 1/16-12	1
	D848-FS-14-12	1 3/16-12	3/4
	D848-FS-16-08	1 5/16-12	1/2
	D848-FS-16-12	1 5/16-12	3/4
	D848-FS-16-16	1 5/16-12	1
	D848-FS-16-20	1 5/16-12	1 1/4
D848-FS-20-16	1 5/8-12	1	
D848-FS-20-20	1 5/8-12	1 1/4	
D848-FS-20-24	1 5/8-12	1 1/2	
D848-FS-24-20	1 7/8-12	1 1/4	
D848-FS-24-24	1 7/8-12	1 1/2	
D848-FS-24-32	1 7/8-12	2	
D848-FS-32-24	2 1/2-12	1 1/2	
D848-FS-32-32	2 1/2-12	2	

REFERENCIA	PARTE No.	JIC T1	O-BOSS T2
<b>D848-FSO</b> Macho JIC a Macho O-RING BOSS	D848-FSO-04-03	7/16-20	3/8-24
	D848-FSO-04-04	7/16-20	7/16-20
	D848-FSO-04-05	7/16-20	1/2-20
	D848-FSO-04-06	7/16-20	9/16-18
	D848-FSO-04-08	7/16-20	3/4-16
	D848-FSO-05-04	1/2-20	7/16-20
	D848-FSO-05-05	1/2-20	1/2-20
	D848-FSO-05-06	1/2-20	9/16-18
	D848-FSO-05-08	1/2-20	3/4-16
	D848-FSO-05-10	1/2-20	7/8-14
	D848-FSO-06-05	9/16-18	1/2-20
	D848-FSO-06-04	9/16-18	7/16-20
	D848-FSO-06-06	9/16-18	9/16-18
	D848-FSO-06-08	9/16-18	3/4-16
	D848-FSO-06-10	9/16-18	7/8-14
	D848-FSO-06-12	9/16-18	1 1/16-12
	D848-FSO-08-04	3/4-16	7/16-20
	D848-FSO-08-06	3/4-16	9/16-18
	D848-FSO-08-08	3/4-16	3/4-16
	D848-FSO-08-10	3/4-16	7/8-14
	D848-FSO-08-12	3/4-16	1 1/16-12
	D848-FSO-08-16	3/4-16	1 5/16-12
	D848-FSO-10-06	7/8-14	9/16-18
	D848-FSO-10-08	7/8-14	3/4-16
	D848-FSO-10-10	7/8-14	7/8-14
	D848-FSO-10-12	7/8-14	1 1/16-12
	D848-FSO-10-14	7/8-14	1 3/16-12
	D848-FSO-10-16	7/8-14	1 5/16-12
	D848-FSO-12-08	1 1/16-12	3/4-16
	D848-FSO-12-10	1 1/16-12	7/8-14
	D848-FSO-12-12	1 1/16-12	1 1/16-12
	D848-FSO-12-14	1 1/16-12	1 3/16-12
	D848-FSO-12-16	1 1/16-12	1 5/16-12
D848-FSO-12-20	1 1/16-12	1 5/8-12	
D848-FSO-14-12	1 3/16-12	1 1/16-12	
D848-FSO-14-14	1 3/16-12	1 3/16-12	
D848-FSO-14-16	1 3/16-12	1 5/16-12	
D848-FSO-16-08	1 5/16-12	3/4-16	
D848-FSO-16-12	1 5/16-12	1 1/16-12	
D848-FSO-16-14	1 5/16-12	1 3/16-12	
D848-FSO-16-16	1 5/16-12	1 5/16-12	
D848-FSO-16-20	1 5/16-12	1 5/8-12	
D848-FSO-16-24	1 5/16-12	1 7/8-12	
D848-FSO-20-12	1 5/8-12	1 1/16-12	
D848-FSO-20-16	1 5/8-12	1 5/16-12	
D848-FSO-20-20	1 5/8-12	1 5/8-12	
D848-FSO-20-24	1 5/8-12	1 7/8-12	
D848-FSO-24-20	1 7/8-12	1 5/8-12	
D848-FSO-24-24	1 7/8-12	1 7/8-12	
D848-FSO-32-24	2 1/2-12	1 7/8-12	
D848-FSO-32-32	2 1/2-12	2 1/2-12	

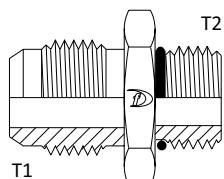

REFERENCIA	PARTE No.	JIC T1	NPTF T2	
<b>D848L-FS</b> Macho JIC - Macho NPTF Largo	D848L-FS-04-02	7/16-20	1/8	
	D848L-FS-04-04	7/16-20	1/4	
	D848L-FS-05-02	1/2-20	1/8	
	D848L-FS-06-06	9/16-18	3/8	
	D848L-FS-08-08	3/4-16	1/2	
	D848L-FS-10-08	7/8-14	1/2	
	D848L-FS-12-12	1 1/16-12	3/4	
	D848L-FS-16-16	1 5/16-12	1	
	D848L-FS-20-20	1 5/8-12	1 1/4	

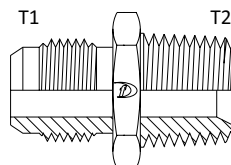

REFERENCIA	PARTE No.	JIC T1	O-BOSS T2	
<b>D848L-FSO</b> Macho JIC - Macho O-Ring Boss Largo	D848L-FSO-03	3/8-24	3/8-24	
	D848L-FSO-04	7/16-20	7/16-20	
	D848L-FSO-05	1/2-20	1/2-20	
	D848L-FSO-06	9/16-18	9/16-18	
	D848L-FSO-08	3/4-16	3/4-16	
	D848L-FSO-10	7/8-14	7/8-14	
	D848L-FSO-12	1 1/16-12	1 1/16-12	
	D848L-FSO-12-10	1 1/16-12	7/8-14	
	D848L-FSO-14	1 3/16-12	1 3/16-12	
	D848L-FSO-16	1 5/16-12	1 5/16-12	
	D848L-FSO-20	1 5/8-12	1 5/8-12	
	D848L-FSO-24	1 7/8-12	1 7/8-12	
	D848L-FSO-32	2 1/2-12	2 1/2-12	

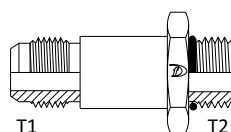

REFERENCIA	PARTE No.	JIC T1	NPTF T2
<b>D849-FS</b> Codo 90° Macho JIC - Macho NPTF	D849-FS-02-02	5/16-24	1/8
	D849-FS-03-02	3/8-24	1/8
	D849-FS-04-02	7/16-20	1/8
	D849-FS-04-04	7/16-20	1/4
	D849-FS-04-06	7/16-20	3/8
	D849-FS-04-08	7/16-20	1/2
	D849-FS-05-02	1/2-20	1/8
	D849-FS-05-04	1/2-20	1/4
	D849-FS-05-06	1/2-20	3/8
	D849-FS-06-02	9/16-18	1/8
	D849-FS-06-04	9/16-18	1/4
	D849-FS-06-06	9/16-18	3/8
	D849-FS-06-08	9/16-18	1/2
	D849-FS-06-12	9/16-18	3/4
	D849-FS-08-04	3/4-16	1/4
	D849-FS-08-06	3/4-16	3/8
	D849-FS-08-08	3/4-16	1/2
	D849-FS-08-12	3/4-16	3/4
	D849-FS-10-06	7/8-14	3/8
	D849-FS-10-08	7/8-14	1/2
	D849-FS-10-12	7/8-14	3/4
	D849-FS-12-06	1 1/16-12	3/8
	D849-FS-12-08	1 1/16-12	1/2
	D849-FS-12-12	1 1/16-12	3/4
	D849-FS-12-16	1 1/16-12	1
	D849-FS-14-12	1 3/16-12	3/4
	D849-FS-16-12	1 5/16-12	3/4
	D849-FS-16-16	1 5/16-12	1
	D849-FS-16-20	1 5/16-12	1 1/4
	D849-FS-20-16	1 5/8-12	1
	D849-FS-20-20	1 5/8-12	1 1/4
	D849-FS-20-24	1 5/8-12	1 1/2
	D849-FS-24-20	1 7/8-12	1 1/4
D849-FS-24-24	1 7/8-12	1 1/2	
D849-FS-32-32	2 1/2-12	2	

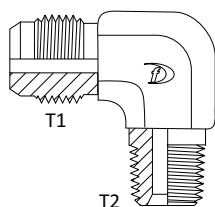

REFERENCIA	PARTE No.	JIC T1	O-BOSS T2
<b>D849-FSO</b> Codo 90° Macho JIC - Macho O-RING BOSS	D849-FSO-02-02	5/16-24	5/16-24
	D849-FSO-03-03	3/8-24	3/8-24
	D849-FSO-04-04	7/16-20	7/16-20
	D849-FSO-04-05	7/16-20	1/2-20
	D849-FSO-04-06	7/16-20	9/16-18
	D849-FSO-05-05	1/2-20	1/2-20
	D849-FSO-05-06	1/2-20	9/16-18
	D849-FSO-05-08	1/2-20	3/4-16
	D849-FSO-06-04	9/16-18	7/16-20
	D849-FSO-06-05	9/16-18	1/2-20
	D849-FSO-06-06	9/16-18	9/16-18
	D849-FSO-06-08	9/16-18	3/4-16
	D849-FSO-06-10	9/16-18	7/8-14
	D849-FSO-06-12	9/16-18	1 1/16-12
	D849-FSO-08-04	3/4-16	7/16-20
	D849-FSO-08-06	3/4-16	9/16-18
	D849-FSO-08-08	3/4-16	3/4-16
	D849-FSO-08-10	3/4-16	7/8-14
	D849-FSO-08-12	3/4-16	1 1/16-12
	D849-FSO-10-06	7/8-14	9/16-18
	D849-FSO-10-08	7/8-14	3/4-16
	D849-FSO-10-10	7/8-14	7/8-14
	D849-FSO-10-12	7/8-14	1 1/16-12
	D849-FSO-10-14	7/8-14	1 3/16-12
	D849-FSO-10-16	7/8-14	1 5/16-12
	D849-FSO-12-08	1 1/16-12	3/4-16
	D849-FSO-12-10	1 1/16-12	7/8-14
	D849-FSO-12-12	1 1/16-12	1 1/16-12
	D849-FSO-12-16	1 1/16-12	1 5/16-12
	D849-FSO-14-14	1 3/16-12	1 3/16-12
	D849-FSO-16-14	1 5/16-12	1 3/16-12
	D849-FSO-16-16	1 5/16-12	1 5/16-12
	D849-FSO-16-20	1 5/16-12	1 5/8-12
D849-FSO-20-16	1 5/8-12	1 5/16-12	
D849-FSO-20-20	1 5/8-12	1 5/8-12	
D849-FSO-20-24	1 5/8-12	1 7/8-12	
D849-FSO-24-24	1 7/8-12	1 7/8-12	
D849-FSO-24-16	1 7/8-12	1 5/16-12	
D849-FSO-32-32	2 1/2-12	2 1/2-12	

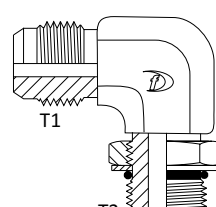



REFERENCIA	PARTE No.	JIC T1	NPTF T2
<b>D849L-FS</b> Codo 90° Macho JIC - Macho NPTF Largo	D849L-FS-02-02	5/16-24	1/8
	D849L-FS-04-02	7/16-20	1/8
	D849L-FS-04-04	7/16-20	1/4
	D849L-FS-05-02	1/2-20	1/8
	D849L-FS-06-04	9/16-18	1/4
	D849L-FS-06-06	9/16-18	3/8
	D849L-FS-06-08	9/16-18	1/2
	D849L-FS-08-06	3/4-16	3/8
	D849L-FS-08-08	3/4-16	1/2
	D849L-FS-10-08	7/8-14	1/2
	D849L-FS-12-12	1 1/16-12	3/4
	D849L-FS-14-12	1 3/16-12	3/4
	D849L-FS-16-16	1 5/16-12	1
	D849L-FS-20-20	1 5/8-12	1 1/4
	D849L-FS-24-24	1 7/8-12	1 1/2
D849L-FS-32-32	2 1/2-12	2	

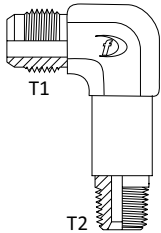

REFERENCIA	PARTE No.	JIC T1	O-BOSS T2
<b>D849L-FSO</b> Codo 90° Macho JIC - Macho O-RING BOSS	D849L-FSO-06-06	9/16-18	9/16-18
	D849L-FSO-08-08	3/4-16	3/4-16
	D849L-FSO-10-10	7/8-14	7/8-14
	D849L-FSO-12-12	1 1/16-12	1 1/16-12

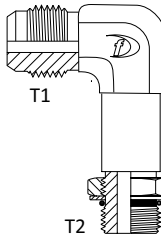

REFERENCIA	PARTE No.	JIC T1	NPTF T2
<b>D849LL-FS</b> Codo 90° Macho JIC - Macho NPTF Largo	D849LL-FS-02-02	5/16-24	1/8
	D849LL-FS-03-02	3/8-24	1/8
	D849LL-FS-04-02	7/16-20	1/8
	D849LL-FS-04-04	7/16-20	1/4
	D849LL-FS-05-02	1/2-20	1/8
	D849LL-FS-06-04	9/16-18	1/4
	D849LL-FS-06-06	9/16-18	3/8
	D849LL-FS-08-06	3/4-16	3/8
	D849LL-FS-08-08	3/4-16	1/2
	D849LL-FS-10-08	7/8-14	1/2
	D849LL-FS-12-12	1 1/16-12	3/4
	D849LL-FS-16-16	1 5/16-12	1
	D849LL-FS-20-20	1 5/8-12	1 1/4
	D849LL-FS-24-24	1 7/8-12	1 1/2
	D849LL-FS-32-32	2 1/2-12	2

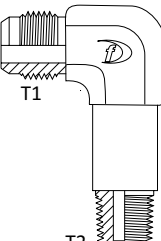

REFERENCIA	PARTE No.	JIC T1	O-BOSS T2
<b>D849LL-FSO</b> Codo 90° Macho JIC - Macho O-RING BOSS Largo	D849LL-FSO-04-04	7/16-20	7/16-20
	D849LL-FSO-06-06	9/16-18	9/16-18
	D849LL-FSO-08-08	3/4-16	3/4-16
	D849LL-FSO-10-10	7/8-14	7/8-14
	D849LL-FSO-12-12	1 1/16-12	1 1/16-12
	D849LL-FSO-16-16	1 5/16-12	1 5/16-12

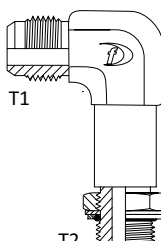

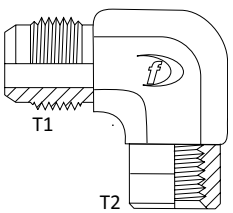
REFERENCIA	PARTE No.	JIC T1	NPTF T2
<b>D850-FS</b> Codo 90° Macho JIC - Hembra NPTF 	D850-FS-02-02	5/16-24	1/8
	D850-FS-03-02	3/8-24	1/8
	D850-FS-04-02	7/16-20	1/8
	D850-FS-04-04	7/16-20	1/4
	D850-FS-05-02	1/2-20	1/8
	D850-FS-05-04	1/2-20	1/4
	D850-FS-06-02	9/16-18	1/8
	D850-FS-06-04	9/16-18	1/4
	D850-FS-06-06	9/16-18	3/8
	D850-FS-08-04	3/4-16	1/4
	D850-FS-08-06	3/4-16	3/8
	D850-FS-08-08	3/4-16	1/2
	D850-FS-10-08	7/8-14	1/2
	D850-FS-12-08	1 1/16-12	1/2
	D850-FS-12-12	1 1/16-12	3/4
	D850-FS-14-12	1 3/16-12	3/4
	D850-FS-16-12	1 5/16-12	3/4
	D850-FS-16-16	1 5/16-12	1
	D850-FS-20-20	1 5/8-12	1 1/4
	D850-FS-24-24	1 7/8-12	1 1/2

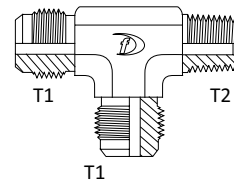
REFERENCIA	PARTE No.	JIC T1	NPTF T2	
<b>D851-FS</b> Tee Macho JIC - Macho NPTF - Macho JIC 	D851-FS-04-02	7/16-20	1/8	
	D851-FS-04-04	7/16-20	1/4	
	D851-FS-05-02	1/2-20	1/8	
	D851-FS-06-04	9/16-18	1/4	
	D851-FS-06-06	9/16-18	3/8	
	D851-FS-08-06	3/4-16	3/8	
	D851-FS-08-08	3/4-16	1/2	
	D851-FS-10-08	7/8-14	1/2	
	D851-FS-12-12	1 1/16-12	3/4	
	D851-FS-14-12	1 3/16-12	3/4	
	D851-FS-16-16	1 5/16-12	1	
	D851-FS-20-20	1 5/8-12	1 1/4	
	D851-FS-24-24	1 7/8-12	1 1/2	
	D851-FS-32-32	2 1/2-12	2	

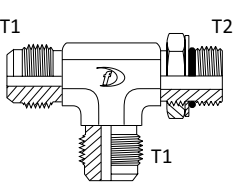
REFERENCIA	PARTE No.	JIC T1	O-BOSS T2
<b>D851-FSO</b> Tee Macho JIC - Macho O-RING BOSS - Macho JIC 	D851-FSO-03-03	3/8-24	3/8-24
	D851-FSO-04-04	7/16-20	7/16-20
	D851-FSO-05-05	1/2-20	1/2-20
	D851-FSO-06-06	9/16-18	9/16-18
	D851-FSO-08-08	3/4-16	3/4-16
	D851-FSO-10-10	7/8-14	7/8-14
	D851-FSO-12-12	1 1/16-12	1 1/16-12
	D851-FSO-14-14	1 3/16-12	1 3/16-12
	D851-FSO-16-16	1 5/16-12	1 5/16-12
	D851-FSO-20-20	1 5/8-12	1 5/8-12
	D851-FSO-24-24	1 7/8-12	1 7/8-12
	D851-FSO-32-32	2 1/2-12	2 1/2-12

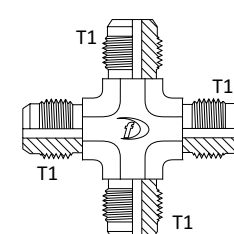
REFERENCIA	PARTE No.	JIC T1	
<b>D852-FS</b> Cruz Macho JIC 	D852-FS-04	7/16-20	
	D852-FS-05	1/2-20	
	D852-FS-06	9/16-18	
	D852-FS-08	3/4-16	
	D852-FS-10	7/8-14	
	D852-FS-12	1 1/16-12	
	D852-FS-14	1 3/16-12	
	D852-FS-16	1 5/16-12	
	D852-FS-20	1 5/8-12	
	D852-FS-24	1 7/8-12	
	D852-FS-32	2 1/2-12	

REFERENCIA	PARTE No.	JIC T1	NPTF T2
<b>D854-FS</b> Codo 45° Macho JIC a Macho NPTF	D854-FS-02-02	5/16-24	1/8
	D854-FS-03-02	3/8-24	1/8
	D854-FS-04-02	7/16-20	1/8
	D854-FS-04-04	7/16-20	1/4
	D854-FS-05-02	1/2-20	1/8
	D854-FS-05-04	1/2-20	1/4
	D854-FS-06-02	9/16-18	1/8
	D854-FS-06-04	9/16-18	1/4
	D854-FS-06-06	9/16-18	3/8
	D854-FS-06-08	9/16-18	1/2
	D854-FS-08-04	3/4-16	1/4
	D854-FS-08-06	3/4-16	3/8
	D854-FS-08-08	3/4-16	1/2
	D854-FS-08-12	3/4-16	3/4
	D854-FS-10-06	7/8-14	3/8
	D854-FS-10-08	7/8-14	1/2
	D854-FS-12-08	1 1/16-12	1/2
	D854-FS-12-12	1 1/16-12	3/4
	D854-FS-12-16	1 1/16-12	1
	D854-FS-16-12	1 5/16-12	3/4
D854-FS-16-16	1 5/16-12	1	
D854-FS-16-20	1 5/16-12	1 1/4	
D854-FS-20-20	1 5/8-12	1 1/4	
D854-FS-24-24	1 7/8-12	1 1/2	
D854-FS-32-32	2 1/2-12	2	

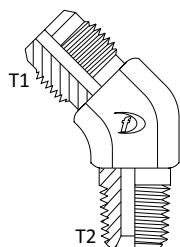

REFERENCIA	PARTE No.	JIC T1	O-BOSS T2
<b>D854-FSO</b> Codo 45° Macho JIC - Macho O-RING BOSS	D854-FSO-02-02	5/16-24	5/16-24
	D854-FSO-03-03	3/8-24	3/8-24
	D854-FSO-04-04	7/16-20	7/16-20
	D854-FSO-05-05	1/2-20	1/2-20
	D854-FSO-06-04	9/16-18	7/16-20
	D854-FSO-06-06	9/16-18	9/16-18
	D854-FSO-06-08	9/16-18	3/4-16
	D854-FSO-08-04	3/4-16	7/16-20
	D854-FSO-08-08	3/4-16	3/4-16
	D854-FSO-08-10	3/4-16	7/8-14
	D854-FSO-08-08	7/8-14	3/4-16
	D854-FSO-10-10	7/8-14	7/8-14
	D854-FSO-10-12	7/8-14	1 1/16-12
	D854-FSO-12-10	1 1/16-12	7/8-14
	D854-FSO-12-12	1 1/16-12	1 1/16-12
	D854-FSO-12-16	1 1/16-12	1 5/16-12
	D854-FSO-14-14	1 3/16-12	1 3/16-12
	D854-FSO-16-12	1 5/16-12	1 1/16-12
	D854-FSO-16-16	1 5/16-12	1 5/16-12
	D854-FSO-20-20	1 5/8-12	1 5/8-12
D854-FSO-24-24	1 7/8-12	1 7/8-12	

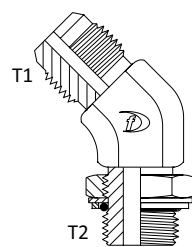

REFERENCIA	PARTE No.	JIC T1	
<b>D854BH-FS</b> Codo 45° Macho JIC - Macho JIC Pasamuro	D854BH-FS-04	7/16-20	
	D854BH-FS-05	1/2-20	
	D854BH-FS-06	9/16-18	
	D854BH-FS-08	3/4-16	
	D854BH-FS-10	7/8-14	
	D854BH-FS-12	1 1/16-12	
	D854BH-FS-14	1 3/16-12	
	D854BH-FS-16	1 5/16-12	
	D854BH-FS-20	1 5/8-12	
	D854BH-FS-24	1 7/8-12	
D854BH-FS-32	2 1/2-12		

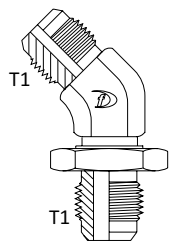

REFERENCIA	PARTE No.	JIC T1	
<b>D855-FS</b> Codo 90° Macho JIC - Macho JIC	D855-FS-02	5/16-24	
	D855-FS-03	3/4-24	
	D855-FS-04	7/16-20	
	D855-FS-05	1/2-20	
	D855-FS-06	9/16-18	
	D855-FS-08	3/4-16	
	D855-FS-10	7/8-14	
	D855-FS-12	1 1/16-12	
	D855-FS-14	1 3/16-12	
	D855-FS-16	1 5/16-12	
	D855-FS-20	1 5/8-12	
	D855-FS-24	1 7/8-12	
	D855-FS-32	2 1/2-12	

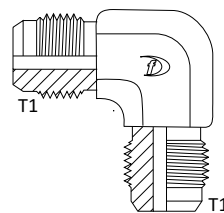

REFERENCIA	PARTE No.	JIC T1		
<b>D855BH-FS</b> Codo 90° Pasamuro Macho JIC - Macho JIC	D855BH-FS-04	7/16-20		
	D855BH-FS-05	1/2-20		
	D855BH-FS-06	9/16-18		
	D855BH-FS-08	3/4-16		
	D855BH-FS-10	7/8-14		
	D855BH-FS-12	1 1/16-12		
	D855BH-FS-14	1 3/16-12		
	D855BH-FS-16	1 5/16-12		
	D855BH-FS-20	1 5/8-12		
	D855BH-FS-24	1 7/8-12		
	D855BH-FS-32	2 1/2-12		

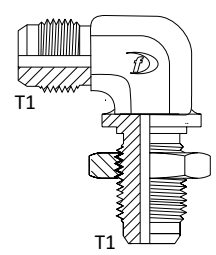

REFERENCIA	PARTE No.	JIC T1	NPTF T2	
<b>D857-FS</b> TEE Macho JIC - Hembra NPTF - Macho JIC	D857-FS-04-02	7/16-20	1/8	
	D857-FS-05-02	1/2-20	1/8	
	D857-FS-06-04	9/16-18	1/4	
	D857-FS-08-06	3/4-16	3/8	
	D857-FS-10-08	7/8-14	1/2	
	D857-FS-12-12	1 1/16-12	3/4	
	D857-FS-14-12	1 3/16-12	3/4	
	D857-FS-16-16	1 5/16-12	1	

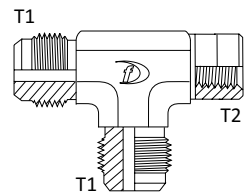

REFERENCIA	PARTE No.	JIC T1	NPTF T2
<b>D858-FS</b> TEE Macho JIC - Macho JIC - Hembra NPTF	D858-FS-02-02	5/16-24	1/8
	D858-FS-04-02	7/16-20	1/8
	D858-FS-04-04	7/16-20	1/4
	D858-FS-05-02	1/2-20	1/8
	D858-FS-06-04	9/16-18	1/4
	D858-FS-06-06	9/16-18	3/8
	D858-FS-08-06	3/4-16	3/8
	D858-FS-08-08	3/4-16	1/2
	D858-FS-10-08	7/8-14	1/2
	D858-FS-12-12	1 1/16-12	3/4
	D858-FS-14-12	1 3/16-12	3/4
	D858-FS-16-16	1 5/16-12	1
	D858-FS-20-20	1 5/8-12	1 1/4
	D858-FS-24-24	1 7/8-12	1 1/2

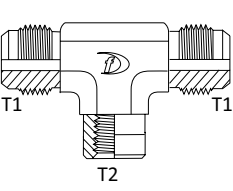

REFERENCIA	PARTE No.	JIC T1	JIC T2
<b>D861-FS</b> TEE Pasamuro Macho JIC	D861-FS-06-06	9/16-18	9/16-18
	D861-FS-08-08	3/4-16	3/4-16
	D861-FS-12-12	1 1/16-12	1 1/16-12

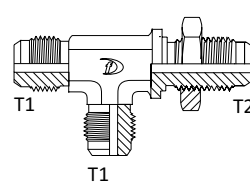

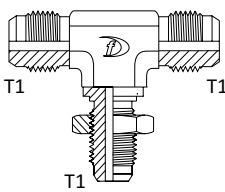
REFERENCIA	PARTE No.	JIC T1	JIC T2
<b>D870-FS</b> TEE Macho JIC Pasamuro 	D870-FS-04	7/16-20	
	D870-FS-05	1/2-20	
	D870-FS-06	9/16-18	
	D870-FS-08	3/4-16	
	D870-FS-10	7/8-14	
	D870-FS-12	1 1/16-12	

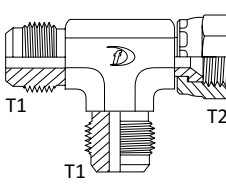
REFERENCIA	PARTE No.	JIC T1	JIC T2	
<b>D871-FS</b> TEE Macho JIC - Hembra JIC - Macho JIC 	D871-FS-03	3/8-24	3/8-24	
	D871-FS-04	7/16-20	7/16-20	
	D871-FS-05	1/2-20	1/2-20	
	D871-FS-06	9/16-18	9/16-18	
	D871-FS-08	3/4-16	3/4-16	
	D871-FS-10	7/8-14	7/8-14	
	D871-FS-12	1 1/16-12	1 1/16-12	
	D871-FS-14	1 3/16-12	1 3/16-12	
	D871-FS-16	1 5/16-12	1 5/16-12	
	D871-FS-20	1 5/8-12	1 5/8-12	
	D871-FS-24	1 7/8-12	1 7/8-12	

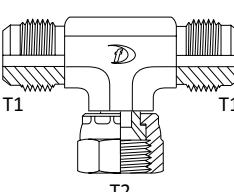
REFERENCIA	PARTE No.	JIC T1	JIC T2
<b>D872-FS</b> TEE Macho JIC - Hembra JIC - Macho JIC 	D872-FS-04	7/16-20	7/16-20
	D872-FS-05	1/2-20	1/2-20
	D872-FS-06	9/16-18	9/16-18
	D872-FS-08	3/4-16	3/4-16
	D872-FS-10	7/8-14	7/8-14
	D872-FS-12	1 1/16-12	1 1/16-12
	D872-FS-14	1 3/16-12	1 3/16-12
	D872-FS-16	1 5/16-12	1 5/16-12
	D872-FS-20	1 5/8-12	1 5/8-12
	D872-FS-24	1 7/8-12	1 7/8-12

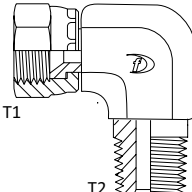
REFERENCIA	PARTE No.	JIC T1	NPTF T2
<b>D878-FS</b> Codo 90° Hembra JIC - Macho NPTF 	D878-FS-06-04	9/16-18	1/4
	D878-FS-08-08	3/4-16	1/2
	D878-FS-10-08	7/8-14	1/2
	D878-FS-12-12	1 1/16-12	3/4
	D878-FS-16-16	1 5/16-12	1
	D878-FS-24-24	1 7/8-12	1 1/2

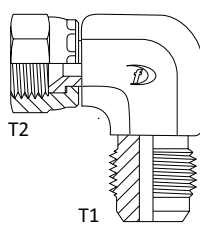
REFERENCIA	PARTE No.	JIC T1	JIC T2
<b>D879-FS</b> Codo 90° Macho JIC - Hembra JIC 	D879-FS-02	5/16-24	5/16-24
	D879-FS-03	3/8-24	3/8-24
	D879-FS-04	7/16-20	7/16-20
	D879-FS-05	1/2-20	1/2-20
	D879-FS-05-06	1/2-20	9/16-18
	D879-FS-06	9/16-18	9/16-18
	D879-FS-08	3/4-16	3/4-16
	D879-FS-08-06	3/4-16	9/16-18
	D879-FS-10	7/8-14	7/8-14
	D879-FS-10-12	7/8-14	1 1/16-12
	D879-FS-12	1 1/16-12	1 1/16-12
	D879-FS-14	1 3/16-12	1 3/16-12
	D879-FS-16	1 5/16-12	1 5/16-12
	D879-FS-20	1 5/8-12	1 5/8-12
	D879-FS-24	7/8-12	7/8-12
	D879-FS-32	2 1/2-12	2 1/2-12

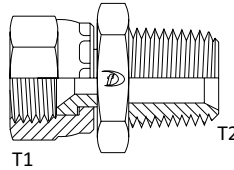
REFERENCIA	PARTE No.	NPTF T1	JIC T2	
<b>D881-FS</b> Hembra JIC - Macho NPTF 	D881-FS-04-04	1/4	7/16-20	
	D881-FS-06-06	3/8	9/16-18	
	D881-FS-08-06	3/8	3/4-16	
	D881-FS-08-08	1/2	3/4-16	
	D881-FS-10-08	1/2	7/8-14	
	D881-FS-12-12	3/4	1 1/16-12	
	D881-FS-16-16	1	1 5/16-12	
	D881-FS-20-20	1 1/4	1 5/8-12	

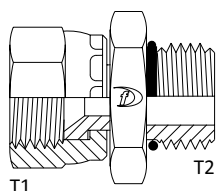
REFERENCIA	PARTE No.	JIC T1	O-BOSS T2
<b>D881-FSO</b> Hembra JIC - Macho O-RING BOSS 	D881-FSO-04-06	7/16-20	9/16-18
	D881-FSO-06-06	9/16-18	9/16-18
	D881-FSO-06-08	9/16-18	3/4-16
	D881-FSO-12-12	1 1/16-12	1 1/16-12

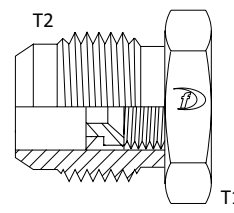
REFERENCIA	PARTE No.	JIC T1	JIC T2
<b>D883-FS</b> Reductor Hembra JIC - Macho JIC 	D883-FS-03-04	3/8-24	7/16-20
	D883-FS-04-06	7/16-20	9/16-18
	D883-FS-05-04	1/2-20	7/16-20
	D883-FS-06-04	9/16-18	7/16-20
	D883-FS-06-05	9/16-18	1/2-20
	D883-FS-06-08	9/16-18	3/4-16
	D883-FS-08-04	3/4-16	7/16-20
	D883-FS-08-06	3/4-16	9/16-18
	D883-FS-08-10	3/4-16	7/8-14
	D883-FS-08-12	3/4-16	1 1/16-12
	D883-FS-10-04	7/8-14	7/16-20
	D883-FS-10-06	7/8-14	9/16-18
	D883-FS-10-08	7/8-14	3/4-16
	D883-FS-10-12	7/8-14	1 1/16-12
	D883-FS-12-04	1 1/16-12	7/16-20
	D883-FS-12-06	1 1/16-12	9/16-18
	D883-FS-12-08	1 1/16-12	3/4-16
	D883-FS-12-10	1 1/16-12	7/8-14
	D883-FS-12-16	1 1/16-12	1 5/16-12
	D883-FS-14-04	1 3/16-12	7/16-20
	D883-FS-14-08	1 3/16-12	3/4-16
	D883-FS-14-10	1 3/16-12	7/8-14
	D883-FS-14-12	1 3/16-12	1 1/16-12
	D883-FS-16-04	1 5/16-12	7/16-20
	D883-FS-16-08	1 5/16-12	3/4-16
	D883-FS-16-10	1 5/16-12	7/8-14
	D883-FS-16-12	1 5/16-12	1 1/16-12
	D883-FS-16-14	1 5/16-12	1 3/16-12
	D883-FS-16-20	1 5/16-12	1 5/8-12
	D883-FS-20-12	1 5/8-12	1 1/16-12
	D883-FS-20-16	1 5/8-12	1 5/16-12
	D883-FS-20-24	1 5/8-12	1 7/8-12
D883-FS-24-20	1 7/8-12	1 5/8-12	
D883-FS-24-32	1 7/8-12	2 1/2-12	
D883-FS-32-24	2 1/2-12	1 7/8-12	

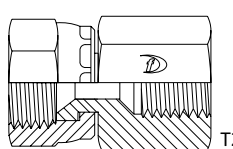
REFERENCIA	PARTE No.	JIC T1	NPTF T2	
<b>D882-FS</b> Hembra JIC - Hembra NPTF 	D882-FS-04-02	7/16-20	1/8	
	D882-FS-04-04	7/16-20	1/4	
	D882-FS-06-04	9/16-18	1/4	
	D882-FS-06-06	9/16-18	3/8	
	D882-FS-06-08	9/16-18	1/2	
	D882-FS-08-08	3/4-16	1/2	
	D882-FS-10-08	7/8-14	1/2	
	D882-FS-12-12	1 1/16-12	3/4	
	D882-FS-16-16	1 5/16-12	1	
	D882-FS-20-20	1 5/8-12	1 1/4	

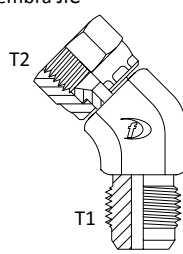

REFERENCIA	PARTE No.	JIC T1	JIC T2
<b>D889-FS</b> Codo 45° Macho JIC- Hembra JIC 	D889-FS-04	7/16-20	7/16-20
	D889-FS-05	1/2-20	1/2-20
	D889-FS-06	9/16-18	9/16/18
	D889-FS-08	3/4-16	3/4-16
	D889-FS-10	7/8-14	7/8-14
	D889-FS-12	1 1/16-12	1 1/16-12
	D889-FS-14	1 3/16-12	1 3/16-12
	D889-FS-16	1 5/16-12	1 5/16-12
	D889-FS-20	1 5/8-12	1 5/8-12
	D889-FS-24	1 7/8-12	1 7/8-12

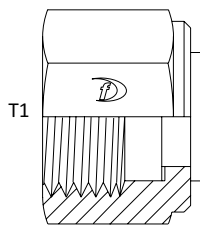
REFERENCIA	PARTE No.	ORFS T1	
<b>D830-TT</b> Tapon - ORFS 	D830-TT-04	9/16-18	
	D830-TT-06	11/16-16	
	D830-TT-08	13/16-16	
	D830-TT-10	1-14	
	D830-TT-12	1 3/16-12	
	D830-TT-16	1 7/16-12	
	D830-TT-20	1 11/16-12	
	D830-TT-24	2-12	

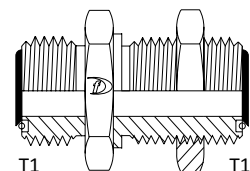
REFERENCIA	PARTE No.	ORFS T1	
<b>D832-TT</b> Macho ORFS - Ajuste Macho ORFS 	D832-TT-04	9/16-18	
	D832-TT-06	11/16-16	
	D832-TT-08	13/16-16	
	D832-TT-10	1-14	
	D832-TT-12	1 3/16-12	
	D832-TT-16	1 7/16-12	
	D832-TT-20	1 11/16-12	
	D832-TT-24	2-12	

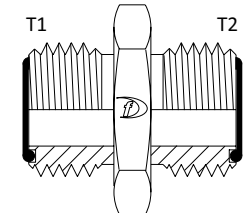
REFERENCIA	PARTE No.	ORFS T1	ORFS T2
<b>D842-TT</b> Macho ORFS - Macho ORFS 	D842-TT-04-04	9/16-18	9/16-18
	D842-TT-06-06	11/16-16	11/16-16
	D842-TT-08-06	13/16-16	11/16-16
	D842-TT-08-08	13/16-16	13/16-16
	D842-TT-10-08	1-14	13/16-16
	D842-TT-10-10	1-14	1-14
	D842-TT-12-12	1 3/16-12	1 3/16-12
	D842-TT-16-16	1 7/16-12	1 7/16-12
	D842-TT-20-20	1 11/16-12	1 11/16-12
	D842-TT-24-24	2-12	2-12

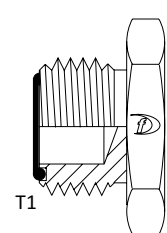
REFERENCIA	PARTE No.	ORFS T1	
<b>D839-TT</b> Tapón - Macho ORFS 	D839-TT-04	9/16-18	
	D839-TT-06	11/16-16	
	D839-TT-08	13/16-16	
	D839-TT-10	1-14	
	D839-TT-12	1 3/16-12	
	D839-TT-16	1 7/16-12	
	D839-TT-20	1 11/16-12	
	D839-TT-24	2-12	

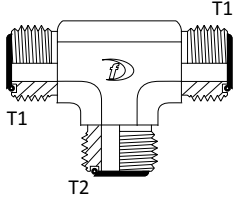
REFERENCIA	PARTE No.	ORFS T1	ORFS T2
<b>D844-TT</b> TEE Macho ORFS 	D844-TT-04	9/16-18	9/16-18
	D844-TT-06	11/16-16	11/16-16
	D844-TT-08	13/16-16	13/16-16
	D844-TT-10	1-14	1-14
	D844-TT-10-10-08	1-14	13/16-16
	D844-TT-10-10-12	1-14	1 3/16-12
	D844-TT-12	1 3/16-12	1 3/16-12
	D844-TT-12-12-16	1 3/16-12	1 7/16-12
	D844-TT-16	1 7/16-12	1 7/16-12
	D844-TT-16-16-20	1 7/16-12	1 11/16-12
	D844-TT-20	1 11/16-12	1 11/16-12
	D844-TT-24	2-12	2-12

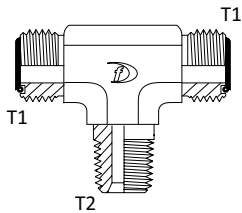
REFERENCIA	PARTE No.	ORFS T1	NPTF T2
<b>D845-TT</b> TEE Macho ORFS - Macho ORFS - Macho NPTF 	D845-TT-04-04	9/16-18	1/4
	D845-TT-06-04	11/16-16	1/4
	D845-TT-06-06	11/16-16	3/8
	D845-TT-08-06	13/16-16	3/8
	D845-TT-08-08	13/16-16	1/2
	D845-TT-10-08	1-14	1/2
	D845-TT-12-12	1 3/16-12	3/4
	D845-TT-16-16	1 7/16-12	1
	D845-TT-20-20	1 11/16-12	1 1/4
	D845-TT-24-24	2-12	1-1/2

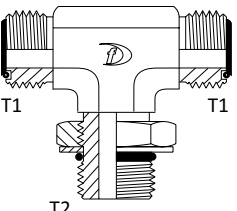
REFERENCIA	PARTE No.	ORFS T1	O-BOSS T2
<b>D845-TTO</b> TEE Macho ORFS - Macho ORFS - Macho O-RING BOSS 	D845-TTO-04-04	9/16-18	7/16-20
	D845-TTO-06-06	11/16-16	9/16-18
	D845-TTO-08-08	13/16-16	3/4-16
	D845-TTO-10-10	1-14	7/8-14
	D845-TTO-12-12	1 3/16-12	1 1/16-12
	D845-TTO-12-16	1 3/16-12	1 5/16-12
	D845-TTO-16-16	1 7/16-12	1 5/16-12
	D845-TTO-20-20	1 11/16-12	1 5/8-12
	D845-TTO-24-24	2-12	1 7/8-12

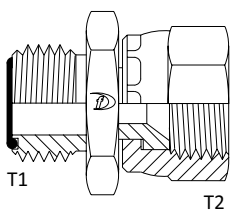
REFERENCIA	PARTE No.	ORFS T1	NPTF T2
<b>D846-TT</b> Macho ORFS - Hembra NPTF 	D846-TT-06-06	11/16-16	3/8
	D846-TT-08-08	13/16-16	1/2
	D846-TT-12-12	1 3/16-12	3/4
	D846-TT-16-16	1 7/16-12	1

REFERENCIA	PARTE No.	ORFS T1	NPTF T2
<b>D848-TT</b> Macho ORFS - Macho NPTF	D848-TT-04-02	9/16-18	1/8
	D848-TT-04-04	9/16-18	1/4
	D848-TT-04-06	9/16-18	3/8
	D848-TT-04-08	9/16-18	1/2
	D848-TT-06-04	11/16-16	1/4
	D848-TT-06-06	11/16-16	3/8
	D848-TT-06-08	11/16-16	1/2
	D848-TT-08-04	13/16-16	1/4
	D848-TT-08-06	13/16-16	3/8
	D848-TT-08-08	13/16-16	1/2
	D848-TT-08-12	13/16-16	3/4
	D848-TT-10-08	1-14	1/2
	D848-TT-10-12	1-14	3/4
	D848-TT-12-08	1 3/16-12	1/2
	D848-TT-12-12	1 3/16-12	3/4
	D848-TT-12-16	1 3/16-12	1
	D848-TT-16-12	1 7/16-12	3/4
	D848-TT-16-16	1 7/16-12	1
	D848-TT-16-20	1 7/16-12	1 1/4
	D848-TT-20-16	1 11/16-12	1
	D848-TT-20-20	1 11/16-12	1 1/4
	D848-TT-24-24	2-12	1-12

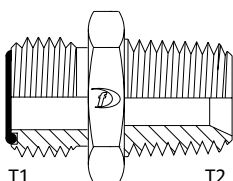

REFERENCIA	PARTE No.	ORFS T1	O-BOSS T2
<b>D848-TTO</b> Macho ORFS - Macho O-RING BOSS	D848-TTO-04-02	9/16-18	5/16-24
	D848-TTO-04-04	9/16-18	7/16-20
	D848-TTO-04-06	9/16-18	9/16-18
	D848-TTO-04-08	9/16-18	3/4-16
	D848-TTO-06-04	11/16-16	7/16-20
	D848-TTO-06-06	11/16-16	9/16-18
	D848-TTO-06-08	11/16-16	3/4-16
	D848-TTO-06-10	11/16-16	7/8-14
	D848-TTO-06-12	11/16-16	1 1/16-12
	D848-TTO-08-06	13/16-16	9/16-18
	D848-TTO-08-08	13/16-16	3/4-16
	D848-TTO-08-10	13/16-16	7/8-14
	D848-TTO-08-12	13/16-16	1 1/16-12
	D848-TTO-08-14	13/16-16	1 3/16-12
	D848-TTO-08-16	13/16-16	1 5/16-12
	D848-TTO-10-06	1-14	9/16-18
	D848-TTO-10-08	1-14	3/4-16
	D848-TTO-10-10	1-14	7/8-14
	D848-TTO-10-12	1-14	1 1/16-12
	D848-TTO-10-16	1-14	1 5/16-12
	D848-TTO-12-06	1 3/16-12	9/16-18
	D848-TTO-12-08	1 3/16-12	3/4-16
	D848-TTO-12-10	1 3/16-12	7/8-14
	D848-TTO-12-12	1 3/16-12	1 1/16-12
	D848-TTO-12-14	1 3/16-12	1 3/16-12
	D848-TTO-12-16	1 3/16-12	1 5/16-12
	D848-TTO-16-10	1 7/16-12	7/8-14
	D848-TTO-16-12	1 7/16-12	1 1/16-12
	D848-TTO-16-14	1 7/16-12	1 3/16-12
	D848-TTO-16-16	1 7/16-12	1 5/16-12
	D848-TTO-16-20	1 7/16-12	1 5/8-12
	D848-TTO-16-24	1 7/16-12	1 7/8-12
D848-TTO-20-16	1 11/16-12	1 5/16-12	
D848-TTO-20-20	1 11/16-12	1 5/8-12	
D848-TTO-20-24	1 11/16-12	1 7/8-12	
D848-TTO-24-20	2-12	1 5/8-12	
D848-TTO-24-24	2-12	1 7/8-12	

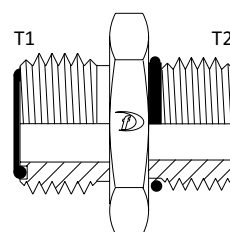

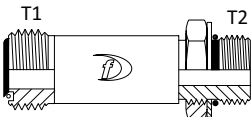
REFERENCIA	PARTE No.	ORFS T1	O-BOSS T2	
<b>D848L-TTO</b> Macho ORFS - Macho O-RING BOSS Largo 	D848L-TTO-04-04	9/16-18	7/16-20	
	D848L-TTO-06-04	11/16-16	7/16-20	
	D848L-TTO-06-06	11/16-16	9/16-18	
	D848L-TTO-08-08	13/16-16	3/4-16	
	D848L-TTO-10-10	1-14	7/8-14	
	D848L-TTO-12-12	1 3/16-12	1 1/16-12	
	D848L-TTO-16-16	1 7/16-12	1 5/16-12	
	D848L-TTO-20-20	1 11/16-12	1 5/8-12	
	D848L-TTO-24-24	2-12	1 7/8-12	

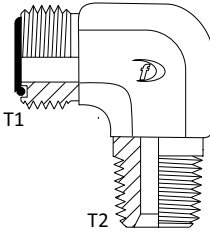
REFERENCIA	PARTE No.	ORFS T1	NPTF T2
<b>D849-TT</b> Codo 90° Macho ORFS - Macho NPTF 	D849-TT-04-02	9/16-18	1/8
	D849-TT-04-04	9/16-18	1/4
	D849-TT-04-06	9/16-18	3/8
	D849-TT-06-04	11/16-16	1/4
	D849-TT-06-06	11/16-16	3/8
	D849-TT-06-08	11/16-16	1/2
	D849-TT-08-06	13/16-16	3/8
	D849-TT-08-08	13/16-16	1/2
	D849-TT-08-12	13/16-16	3/4
	D849-TT-10-08	1-14	1/2
	D849-TT-10-12	1-14	3/4
	D849-TT-12-08	1 3/16-12	1/2
	D849-TT-12-12	1 3/16-12	3/4
	D849-TT-12-16	1 3/16-12	1
	D849-TT-16-12	1 7/16-12	3/4
	D849-TT-16-16	1 7/16-12	1
	D849-TT-20-20	1 11/16-12	1 1/4
	D849-TT-24-24	2-12	1-12

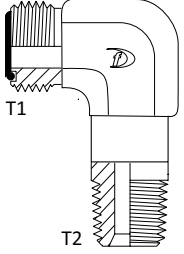
REFERENCIA	PARTE No.	ORFS T1	NPTF T2
<b>D849L-TT</b> Codo 90° Macho ORFS - Macho NPTF Largo 	D849L-TT-16-12	1 7/16-12	3/4

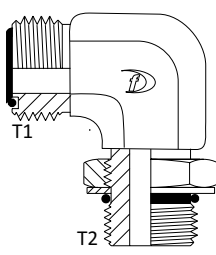
REFERENCIA	PARTE No.	ORFS T1	O-BOSS T2
<b>D849-TTO</b> Codo 90° Macho ORFS - Macho O-RING BOSS 	D849-TTO-04-03	9/16-18	3/8-24
	D849-TTO-04-04	9/16-18	7/16-20
	D849-TTO-04-06	9/16-18	9/16-18
	D849-TTO-04-08	9/16-18	3/4-16
	D849-TTO-06-04	11/16-16	7/16-20
	D849-TTO-06-06	11/16-16	9/16-18
	D849-TTO-06-08	11/16-16	3/4-16
	D849-TTO-06-10	11/16-16	7/8-14
	D849-TTO-06-12	11/16-16	1 1/16-12
	D849-TTO-08-06	13/16-16	9/16-18
	D849-TTO-08-08	13/16-16	3/4-16
	D849-TTO-08-10	13/16-16	7/8-14
	D849-TTO-08-12	13/16-16	1 1/16-12
	D849-TTO-10-08	1-14	3/4-16
	D849-TTO-10-10	1-14	7/8-14
	D849-TTO-10-12	1-14	1 1/16-12
	D849-TTO-10-16	1-14	1 5/16-12
	D849-TTO-12-08	1 3/16-12	3/4-16
	D849-TTO-12-10	1 3/16-12	7/8-14
	D849-TTO-12-12	1 3/16-12	1 1/16-12
	D849-TTO-12-16	1 3/16-12	1 5/16-12
	D849-TTO-16-12	1 7/16-12	1 1/16-12
	D849-TTO-16-16	1 7/16-12	1 5/16-12
	D849-TTO-16-20	1 7/16-12	1 5/8-12
	D849-TTO-20-12	1 11/16-12	1 1/16-12
	D849-TTO-20-16	1 11/16-12	1 5/16-12
	D849-TTO-20-20	1 11/16-12	1 5/8-12
D849-TTO-24-20	2-12	1 5/8-12	
D849-TTO-24-24	2-12	1 7/8-12	

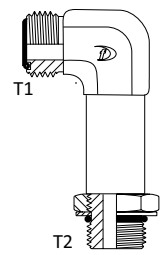
REFERENCIA	PARTE No.	ORFS T1	O-BOSS T2
<b>D849L-TTO</b> Codo 90° Macho ORFS - Macho O-RING BOSS Largo 	D849L-TTO-06-06	11/16-16	9/16-18
	D849L-TTO-12-12	1 3/16-12	1 1/16-12
	D849L-TTO-20-20	1 11/16-12	1 5/8-12

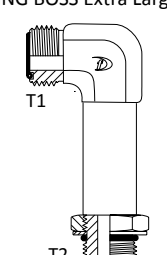
REFERENCIA	PARTE No.	ORFS T1	O-BOSS T2
<b>D849LL-TTO</b> Codo 90° Macho ORFS - Macho O-RING BOSS Extra Largo 	D849LL-TTO-04-04	9/16-18	7/16-20
	D849LL-TTO-10-10	1-14	7/8-14

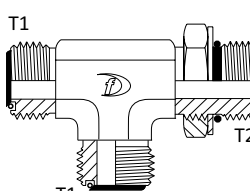
REFERENCIA	PARTE No.	ORFS T1	O-BOSS T2
<b>D851-TTO</b> TEE Macho ORFS - Macho O-RING BOSS a Macho ORFS 	D851-TTO-04-04	9/16-18	7/16-20
	D851-TTO-06-06	11/16-16	9/16-18
	D851-TTO-08-06-08	13/16-16	9/16-18
	D851-TTO-08-08	13/16-16	3/4-16
	D851-TTO-08-10	1-14	7/8-14
	D851-TTO-08-16-08	13/16-16	1 5/16-12
	D851-TTO-10-10	1-14	7/8-14
	D851-TTO-12-12	1 3/16-12	1 1/16-12
	D851-TTO-12-16-12	1 3/16-12	1 5/16-12
	D851-TTO-16-12-16	1 7/16-12	1 1/16-12
	D851-TTO-16-16	1 7/16-12	1 5/16-12
	D851-TTO-20-20	1 11/16-12	1 5/8-12
	D851-TTO-24-24	2-12	1 7/8-12

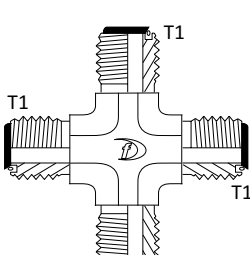
REFERENCIA	PARTE No.	ORFS T1	
<b>D852-TT</b> Cruz Macho ORFS 	D852-TT-06	11/16-16	
	D852-TT-08	1 3/16-16	
	D852-TT-24	2-12	

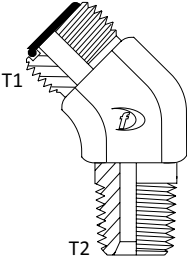
REFERENCIA	PARTE No.	ORFS T1	NPTF T2
<b>D854-TT</b> Codo 45° Macho ORFS - Macho NPTF 	D854-TT-04-04	9/16-18	1/4
	D854-TT-06-04	11/16-16	1/4
	D854-TT-06-06	11/16-16	3/8
	D854-TT-08-06	13/16-16	3/8
	D854-TT-08-08	13/16-16	1/2
	D854-TT-10-08	1-14	1/2
	D854-TT-12-12	1 3/16-12	3/4
	D854-TT-16-16	1 7/16-12	1
	D854-TT-20-20	1 11/16-12	1 1/4
	D854-TT-24-24	2-12	1 1/2

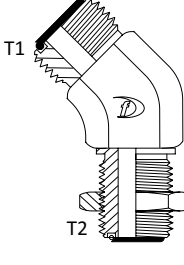
REFERENCIA	PARTE No.	ORFS T1	ORFS T2
<b>D854BH-TT</b> Codo 45° Macho ORFS - Macho ORFS Ajustable 	D854BH-TT-06-06	11/16-16	11/16-16
	D854BH-TT-12-12	1 3/16-12	1 3/16-12
	D854BH-TT-16-16	1 7/16-12	1 7/16-12

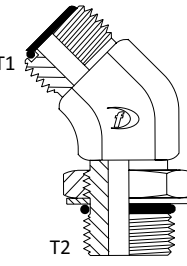
REFERENCIA	PARTE No.	ORFS T1	O-BOSS T2
<b>D854-TTO</b> Codo 45° Macho ORFS a Macho O-RING BOSS 	D854-TTO-04-04	9/16-18	7/16-20
	D854-TTO-04-06	9/16-18	9/16-18
	D854-TTO-06-04	11/16-16	7/16-20
	D854-TTO-06-06	11/16-16	9/16-18
	D854-TTO-06-08	11/16-16	3/4-16
	D854-TTO-08-06	13/16-16	9/16-18
	D854-TTO-08-08	13/16-16	3/4-16
	D854-TTO-08-10	13/16-16	7/8-14
	D854-TTO-10-08	1-14	3/4-16
	D854-TTO-10-10	1-14	7/8-14
	D854-TTO-10-12	1-14	1 1/16-12
	D854-TTO-12-08	1 3/16-12	3/4-16
	D854-TTO-12-10	1 3/16-12	7/8-14
	D854-TTO-12-12	1 3/16-12	1 1/16-12
	D854-TTO-12-16	1 3/16-12	1 5/16-12
	D854-TTO-16-12	1 7/16-12	1 1/16-12
	D854-TTO-16-16	1 7/16-12	1 5/16-12
D854-TTO-16-20	1 7/16-12	1 5/8-12	
D854-TTO-20-16	1 11/16-12	1 5/16-12	
D854-TTO-20-20	1 11/16-12	1 5/8-12	

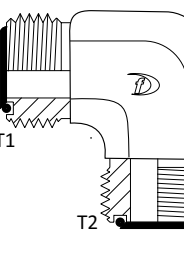
REFERENCIA	PARTE No.	ORFS T1	ORFS T2
<b>D855-TT</b> Codo 90° Macho ORFS - Macho ORFS 	D855-TT-04-04	9/16-18	9/16-18
	D855-TT-06-06	11/16-16	11/16-16
	D855-TT-08-08	13/16-16	13/16-16
	D855-TT-10-10	1-14	1-14
	D855-TT-12-12	1 3/16-12	1 3/16-12
	D855-TT-12-10	1 3/16-12	1/14
	D855-TT-16-16	1 7/16-12	1 7/16-12
	D855-TT-20-20	1 11/16-12	1 11/16-12
	D855-TT-24-24	2-12	2-12

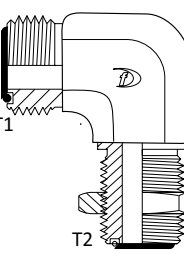
REFERENCIA	PARTE No.	ORFS T1	ORFS T2
<b>D855BH-TT</b> Codo 90° Macho ORFS a Macho ORFS Ajustable 	D855BH-TT-04	9/16-18	9/16-18
	D855BH-TT-06	11/16-16	11/16-16
	D855BH-TT-08	13/16-16	13/16-16
	D855BH-TT-10	1-14	1-14
	D855BH-TT-12	1 3/16-12	1 3/16-12
	D855BH-TT-16	1 7/16-12	1 7/16-12

REFERENCIA	PARTE No.	ORFS T1	ORFS T2
<b>D870-TT</b> TEE Macho ORFS - Macho ORFS - Macho ORFS Largo	D870-TT-04	9/16-18	9/16-18
	D870-TT-06	11/16-16	11/16-16
	D870-TT-08	13/16-16	13/16-16
	D870-TT-10	1-14	1-14
	D870-TT-12	1 3/16-12	1 3/16-12

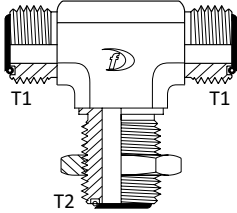

REFERENCIA	PARTE No.	ORFS T1	ORFS T2
<b>D871-TT</b> TEE Macho ORFS a Hembra ORFS - Macho ORFS	D871-TT-04	9/16-18	9/16-18
	D871-TT-06	11/16-16	11/16-16
	D871-TT-08	13/16-16	13/16-16
	D871-TT-12	1 3/16-12	1 3/16-12
	D871-TT-16	1 7/16-12	1 7/16-12
	D871-TT-20	1 11/16-12	1 11/16-12
	D871-TT-24	2-12	2-12

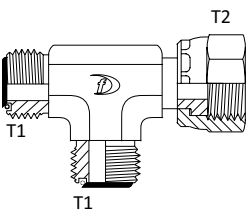

REFERENCIA	PARTE No.	ORFS T1	ORFS T2	
<b>D872-TT</b> TEE Macho ORFS - Macho ORFS - Hembra ORFS	D872-TT-04	9/16-18	9/16-18	
	D872-TT-06	11/16-16	11/16-16	
	D872-TT-08	13/16-16	13/16-16	
	D872-TT-10	1-14	1-14	
	D872-TT-12	1 3/16-12	1 3/16-12	
	D872-TT-16	1 7/16-12	1 7/16-12	
	D872-TT-20	1 11/16-12	1 11/16-12	
	D872-TT-24	2-12	2-12	

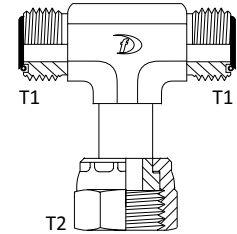

REFERENCIA	PARTE No.	ORFS T1	O-BOSS T2
<b>D878-TTO</b> Codo 90° Hembra ORFS - Macho O-RING BOSS Ajustable	D878-TTO-06-06	11/16-16	9/16-18
	D878-TTO-16-16	1 7/16-12	1 5/16-12
	D878-TTO-24-24	2-12	1 7/8-12

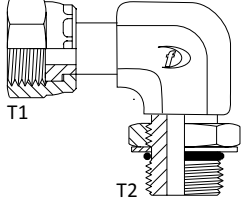

REFERENCIA	PARTE No.	ORFS T1	ORFS T2	
<b>D879-TT</b> Codo 90° Hembra ORFS - Macho ORFS	D879-TT-04	9/16-18	9/16-18	
	D879-TT-04-08	9/16-18	13/16-16	
	D879-TT-06	11/16-16	11/16-16	
	D879-TT-06-08	11/16-16	13/16-16	
	D879-TT-08	13/16-16	13/16-16	
	D879-TT-10	1-14	1-14	
	D879-TT-12	1 3/16-12	1 3/16-12	
	D879-TT-10-16	1-14	1-7/16-12	
	D879-TT-16	1 7/16-12	1 7/16-12	
	D879-TT-16-20	1 7/16-12	1 11/16-12	
	D879-TT-20-16	1 11/16-12	1 7/16-12	
	D879-TT-20	1 11/16-12	1 11/16-12	
	D879-TT-24	2-12	2-12	

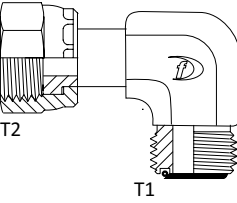

REFERENCIA	PARTE No.	ORFS T1	NPTF T2
<b>D881-TT</b> Hembra ORFS - Macho NPTF	D881-TT-06-06	11/16-16	3/8
	D881-TT-08-08	13/16-16	1/2
	D881-TT-10-08	1-14	1/2
	D881-TT-12-12	1 3/16-12	3/4

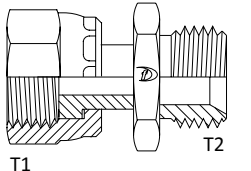



REFERENCIA	PARTE No.	ORFS T1	O-BOSS T2
<b>D881-TTO</b> Hembra ORFS - Macho O-RING BOSS	D881-TTO-08-12	13/16-16	1 1/16-12
	D881-TTO-24-24	2-12	1 7/8-12

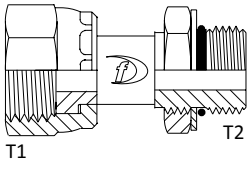

REFERENCIA	PARTE No.	ORFS T1	NPTF T2
<b>D882-TT</b> Hembra ORFS - Hembra NPTF	D882-TT-06-02	11/16-16	1/8

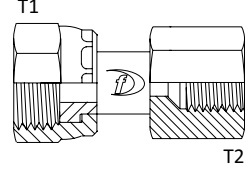

REFERENCIA	PARTE No.	ORFS T1	ORFS T2
<b>D883-TT</b> Hembra ORFS - Macho ORFS Reductor	D883-TT-06-04	11/16-16	9/16-18
	D883-TT-06-08	11/16-16	13/16-16
	D883-TT-08-04	13/16-16	9/16-18
	D883-TT-08-06	13/16-16	11/16-18
	D883-TT-10-08	1-14	13/16-16
	D883-TT-12-04	1 3/16-12	9/16-18
	D883-TT-12-06	1 3/16-12	11/16-16
	D883-TT-12-08	1 3/16-12	13/16-16
	D883-TT-12-10	1 3/16-12	1-14
	D883-TT-16-06	1 7/16-12	11/16-16
	D883-TT-16-08	1 7/16-12	13/16-16
	D883-TT-16-10	1 7/16-12	1-14
	D883-TT-20-12	1 11/16-12	1 3/16-12
	D883-TT-20-16	1 11/16-12	1 7/16-12
	D883-TT-24-12	2-12	1 3/16-12
	D883-TT-24-16	2-12	1 7/16-12
D883-TT-24-20	2-12	1 11/16-12	

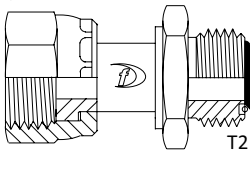

REFERENCIA	PARTE No.	ORFS T1	ORFS T2
<b>D889-TT</b> Codo 45° Hembra ORFS- Macho ORFS	D889-TT-04	9/16-18	9/16-18
	D889-TT-06	11/16-16	11/16-16
	D889-TT-08	13/16-16	13/16-16
	D889-TT-10	1-14	1-14
	D889-TT-12	1 3/16-12	1 3/16-12
	D889-TT-16	1 7/16-12	1 7/16-12
	D889-TT-24	2-12	2-12

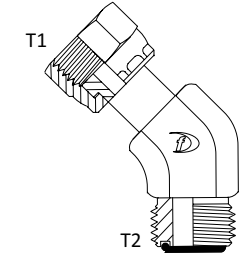

REFERENCIA	PARTE No.	BSPT T1	
<b>D964</b> Tapón Macho BSPT	D964-02	1/8	
	D964-04	1/4	
	D964-06	3/8	
	D964-08	1/2	
	D964-12	3/4	
	D964-16	1	
	D964-20	1 1/4	
	D964-24	1 1/2	
	D964-32	2	

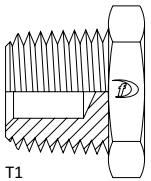

REFERENCIA	PARTE No.	BSPP T1	
<b>D973</b> Tapón Macho BSPP con O-RING	D973-02	1/8	
	D973-04	1/4	
	D973-06	3/8	
	D973-08	1/2	
	D973-12	3/4	
	D973-16	1	
	D973-20	1 1/4	
	D973-24	1 1/2	
	D973-32	2	

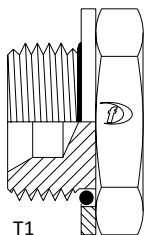

REFERENCIA	PARTE No.	DIN T1	
<b>D973M</b> Tapón Macho DIN	D973M-12-15	12x1 5	
	D973M-14-15	14x1 5	
	D973M-16-15	16x1 5	
	D973M-18-15	18x1 5	
	D973M-20-15	20x1 5	
	D973M-22-15	22x1 5	
	D973M-24-15	24x1 5	
	D973M-26-15	26x1 5	
	D973M-27-20	27x2	
	D973M-28-15	28x1 5	
	D973M-30-20	30x2	
	D973M-33-20	33x2	
	D973M-36-20	36x2	
	D973M-42-20	42x2	
	D973M-52-20	52x2	

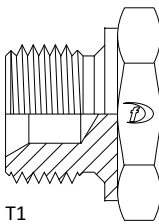

REFERENCIA	PARTE No.	BSPP T1	
<b>D959</b> Tapón Hembra BSPP Giratoria	D959-02	1/8	
	D959-04	1/4	
	D959-06	3/8	
	D959-08	1/2	
	D959-12	3/4	
	D959-16	1	
	D959-20	1 1/4	
	D959-24	1 1/2	
	D959-32	2	

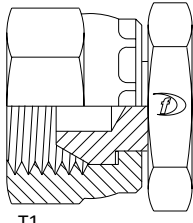

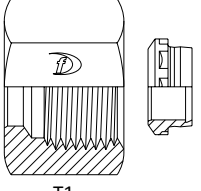
REFERENCIA	PARTE No.	DIN SL T1	
<b>D906ML</b> Tapón Hembra DIN S.L.  T1	D906ML-12-15	12x1 5	
	D906ML-14-15	14x1 5	
	D906ML-16-15	16x1 5	
	D906ML-18-15	18x1 5	
	D906ML-22-15	22x1 5	
	D906ML-26-15	26x1 5	
	D906ML-30-20	30x2 0	
	D906ML-36-20	36x2 0	

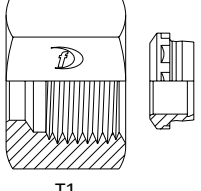
REFERENCIA	PARTE No.	DIN SP T1	
<b>D906MS</b> Tapón Hembra DIN S.P.  T1	D906MS-14-15	14x1 5	
	D906MS-16-15	16x1 5	
	D906MS-18-15	18x1 5	
	D906MS-20-15	20x1 5	
	D906MS-22-15	22x1 5	
	D906MS-24-15	24x1 5	
	D906MS-30-20	30x2	
	D906MS-36-20	36x2	
	D906MS-42-20	42x2	
	D906MS-52-20	52x2	

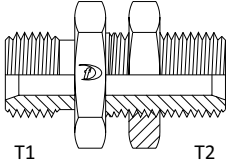
REFERENCIA	PARTE No.	BSPP T1	BSPP T2
<b>D944</b> Pasamuro Macho BSPP - Macho BSPP  T1 T2	D944-04-04	1/4	1/4
	D944-06-06	3/8	3/8
	D944-08-08	1/2	1/2
	D944-12-12	3/4	3/4
	D944-16-16	1	1
	D944-20-20	1.1/4	1.1/4

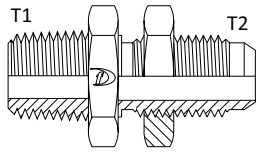
REFERENCIA	PARTE No.	BSPTM T1	JIC T2
<b>D9130</b> Pasamuro Macho BSPTM - Macho JIC  T1 T2	D9130-08-12	1/2	1.1/16

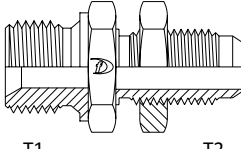
REFERENCIA	PARTE No.	BSPP T1	JIC T2
<b>D9130P</b> Pasamuro Macho BSPP - Macho JIC  T1 T2	D9130P-0606	3/8	9/16
	D9130P-0808	1/2	3/4
	D9130P-0814	1/2	7/8

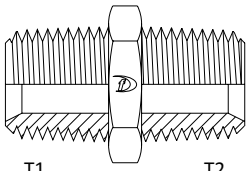
REFERENCIA	PARTE No.	BSPT T1	BSPT T2
<b>D927</b> Macho BSPT - Macho BSPT  	D927-02-02	1/8	1/8
	D927-04-02	1/4	1/8
	D927-04-04	1/4	1/4
	D927-06-04	3/8	1/4
	D927-06-06	3/8	3/8
	D927-08-04	1/2	1/4
	D927-08-06	1/2	3/8
	D927-08-08	1/2	1/2
	D927-10-08	5/8	1/2
	D927-10-10	5/8	5/8
	D927-12-06	3/4	3/8
	D927-12-08	3/4	1/2
	D927-12-10	3/4	5/8
	D927-12-12	3/4	3/4
	D927-16-08	1	1/2
	D927-16-12	1	3/4
	D927-16-16	1	1
	D927-20-12	1.1/4	3/4
	D927-20-16	1.1/4	1
	D927-20-20	1.1/4	1.1/4
	D927-24-12	1.1/2	1
	D927-24-16	1.1/2	1
	D927-24-20	1.1/2	1.1/4
	D927-24-24	1.1/2	1.1/2
	D927-32-20	2	1,1/4
	D927-32-24	2	1,1/2
	D927-32-32	2	2

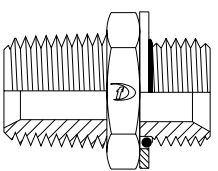
REFERENCIA	PARTE No.	BSPT T1	BSPP O-RING T2
<b>D975</b> Macho BSPT - Macho BSPP O-RING  	D975-04-04	1/4	1/4
	D975-04-06	1/4	3/8
	D975-04-08	1/4	1/2
	D975-06-04	3/8	1/4
	D975-06-06	3/8	3/8
	D975-06-08	3/8	1/2
	D975-08-04	1/2	1/4
	D975-08-06	1/2	3/8
	D975-08-08	1/2	1/2
	D975-08-10	1/2	5/8
	D975-08-12	1/2	3/4
	D975-12-08	3/4	1/2
	D975-12-12	3/4	3/4
	D975-12-16	3/4	1
	D975-16-12	1	3/4
	D975-16-16	1	1
	D975-16-20	1	1.1/4
	D975-20-20	1.1/4	1.1/4
	D975-24-24	1.1/2	1.1/2
	D975-32-32	2	2

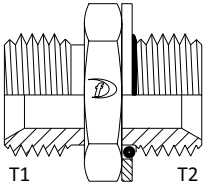
REFERENCIA	PARTE No.	BSPP T1	BSPP O-RING T2
<b>D946</b> Macho BSPP - Macho BSPP O-RING 	D946-04-04	1/4	1/4
	D946-04-06	1/4	3/8
	D946-06-06	3/8	3/8
	D946-06-08	3/8	1/2
	D946-08-04	1/2	1/4
	D946-08-08	1/2	1/2
	D946-08-12	1/2	3/4
	D946-12-12	3/4	3/4
	D946-12-16	3/4	1
	D946-16-16	1	1
	D946-20-20	1.1/4	1.1/4
	D946-20-24	1.1/4	1.1/2
	D946-24-24	1.1/2	1.1/2
	D946-32-32	2	2

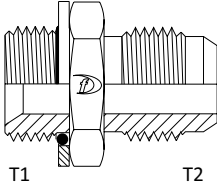
REFERENCIA	PARTE No.	BSPP O-RING T1	JIC T2
<b>D974</b> Macho BSPP O-RING - Macho JIC 	D974-02-04	1/8	7/16
	D974-02-06	1/8	9/16
	D974-04-04	1/4	7/16
	D974-04-05	1/4	1/2
	D974-04-06	1/4	9/16
	D974-04-08	1/4	3/4
	D974-04-12	1/4	1.1/16
	D974-06-04	3/8	7/16
	D974-06-06	3/8	9/16
	D974-06-08	3/8	3/4
	D974-06-10	3/8	7/8
	D974-06-12	3/8	1.1/16
	D974-08-06	1/2	9/16
	D974-08-08	1/2	3/4
	D974-08-10	1/2	7/8
	D974-08-12	1/2	1.1/16
	D974-12-06	3/4	9/16
	D974-12-08	3/4	3/4
	D974-12-10	3/4	7/8
	D974-12-12	3/4	1.1/16
	D974-12-16	3/4	1.5/16
	D974-12-20	3/4	1.5/8
	D974-16-12	1	1.1/16
	D974-16-16	1	1.5/16
	D974-16-20	1	1.5/8
	D974-20-12	1.1/4	1.1/16
	D974-20-16	1.1/4	1.5/16
	D974-20-20	1.1/4	1.5/8
	D974-24-12	1.1/2	1.1/16
	D974-24-16	1.1/2	1.5/16
	D974-24-20	1.1/2	1.5/8
	D974-24-24	1.1/2	1.7/8
D974-32-32	2	2.1/2	

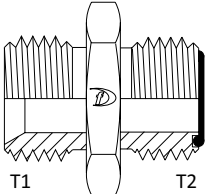
REFERENCIA	PARTE No.	BSPP T1	ORFS T2
<b>D9180</b> Macho BSPP - Macho ORFS 	D9180-04-06	1/4	11/16
	D9180-06-06	3/8	11/16
	D9180-06-08	3/8	13/16
	D9180-08-08	1/2	13/16

REFERENCIA	PARTE No.	BSPT T1	O-BOSS T2
<b>D993</b> Macho BSPT - Macho O-RING BOSS	D993-04-06	1/4	9/16
	D993-04-08	1/4	3/4
	D993-04-10	1/4	7/8
	D993-06-06	3/8	9/16
	D993-06-08	3/8	3/4
	D993-06-10	3/8	7/8
	D993-06-12	3/8	1.1/16
	D993-08-06	1/2	9/16
	D993-08-08	1/2	3/4
	D993-08-10	1/2	7/8
	D993-08-12	1/2	1.1/16
	D993-10-10	5/8	7/8
	D993-10-12	5/8	1.1/16
	D993-12-08	3/4	3/4
	D993-12-10	3/4	7/8
	D993-12-12	3/4	1.1/16
	D993-12-16	3/4	1.5/16
	D993-12-20	3/4	1.5/8
	D993-16-12	1	1.1/16
	D993-16-16	1	1.5/16
	D993-16-20	1	1.5/8
	D993-20-16	1.1/4	1.5/16
	D993-20-16	1.1/4	1.5/8
	D993-24-20	1.1/2	1.5/8
	D993-24-24	1.1/2	1.7/8

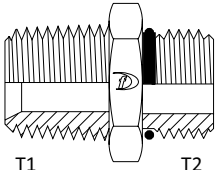

REFERENCIA	PARTE No.	BSPP O-RING T1	DIN SL T2
<b>D975ML</b> Macho BSPP O-RING - Macho DIN S.L.	D975ML-04-14	1/4	14x1 5
	D975ML-01-88	1/2	18x1 5
	D975ML-12-22	3/4	22x1 5

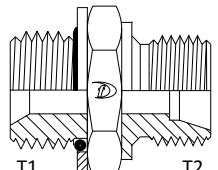

REFERENCIA	PARTE No.	BSPP O-RING T1	DIN SP T2
<b>D975MS</b> Macho BSPP O-RING - Macho DIN S.P.	D975MS-04-16	1/4	16x1 5
	D975MS-02-18	1/8	18x1 5
	D975MS-04-18	1/4	18x1 5
	D975MS-06-18	3/8	18x1 5
	D975MS-06-20	3/8	20x1 5
	D975MS-08-22	1/2	22x1 5
	D975MS-06-24	3/8	24x1 5
	D975MS-08-24	1/2	24x1 5
	D975MS-12-30	3/4	30x2 0
	D975MS-12-36	3/4	36x2 0
	D975MS-16-36	1	36x2 0
	D975MS-20-42	1.1/4	42x2 0
	D975MS-24-52	1.1/2	52x2 0

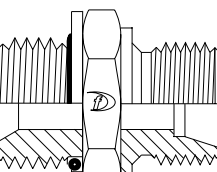

REFERENCIA	PARTE No.	JIC T1	DIN SL T2
<b>D907ML</b> Macho JIC - Macho DIN S.L.	TTML-12-04	7/16	12x1 5
	D907ML-12-06	9/16	12x1 5
	D907ML-14-06	9/16	14x1 5
	D907ML-14-08	3/4	14x1 5
	D907ML-16-04	7/16	16x1 5
	D907ML-18-06	9/16	18x1 5
	D907ML-18-08	3/4	18x1 5
	D907ML-22-08	3/4	22x1 5
	D907ML-22-10	7/8	22x1 5

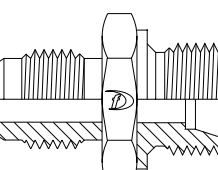

REFERENCIA	PARTE No.	JIC T1	DIN SP T2
<b>D907MS</b> Macho JIC - Macho DIN S.P.	D907MS-18-06	9/16	18x1,5
	D907MS-24-08	3/4	24x1,5
	D907MS-24-12	1.1/16	24x1,5
	D907MS-30-10	7/8	30x2
	D907MS-36-12	1.1/16	36x2
	D907MS-42-16	1.5/16	36x2

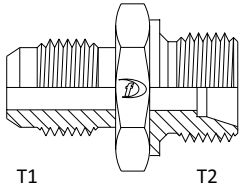

REFERENCIA	PARTE No.	BSPT T1	BSPT T2
<b>D924</b> Bushing Macho BSPT- Hembra BSPT	D924-04-02	1/4	1/8
	D924-06-02	3/8	1/8
	D924-06-04	3/8	1/4
	D924-08-04	1/2	1/4
	D924-08-06	1/2	3/8
	D924-12-04	3/4	1/4
	D924-12-06	3/4	3/8
	D924-12-08	3/4	1/2
	D924-16-06	1	3/8
	D924-16-08	1	1/2
	D924-16-12	1	3/4
	D924-20-08	1.1/4	1/2
	D924-20-12	1.1/4	3/4
	D924-20-16	1.1/4	1
	D924-24-08	1.1/2	1/2
	D924-24-12	1.1/2	3/4
	D924-24-16	1.1/2	1
	D924-24-20	1.1/2	1.1/4
	D924-32-16	2	1
	D924-32-24	2	1.1/2

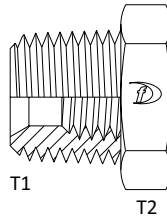

REFERENCIA	PARTE No.	BSP O-RING T1	BSPT T2
<b>D9102</b> Bushing Macho BSP O-RING - Hembra BSPT	D9102-04-02	1/4	1/8
	D9102-06-02	3/8	1/8
	D9102-06-04	3/8	1/4
	D9102-08-04	1/2	1/4
	D9102-08-06	1/2	3/8
	D9102-12-04	3/4	1/4
	D9102-12-06	3/4	3/8
	D9102-12-08	3/4	1/2
	D9102-16-08	1	1/2
	D9102-16-12	1	3/4
	D9102-20-12	1.1/4	3/4
	D9102-20-16	1.1/4	1
	D9102-24-16	1.1/2	1
	D9102-24-20	1.1/2	1.1/4

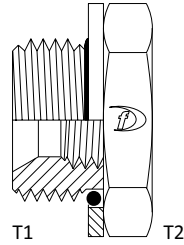

REFERENCIA	PARTE No.	O-BOSS T1	BSPT T2
<b>D985</b> Bushing Macho O-RING BOSS - Hembra BSPT	D985-02-06	9/16	1/8
	D985-02-08	3/4	1/8
	D985-02-10	1.1/16	1/8
	D985-04-08	3/4	1/4
	D985-04-10	7/8	1/4
	D985-04-12	1.1/16	1/4
	D985-04-16	1.5/16	1/4
	D985-06-10	7/8	3/8
	D985-06-12	1.1/16	3/8
	D985-06-16	1.5/16	3/8
	D985-08-10	7/8	1/2
	D985-08-12	1.1/16	1/2
	D985-08-16	1.5/16	1/2
	D985-08-20	1.5/8	1/2
	D985-12-16	1.5/16	3/4
	D985-12-20	1.5/8	3/4
	D985-16-26	1.5/8	1

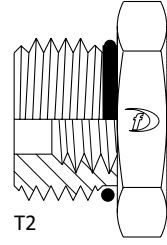

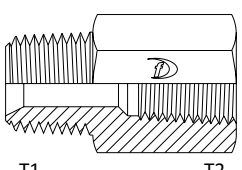

REFERENCIA	PARTE No.	BSPT T1	BSPT T2	
<b>D972</b> Macho BSPT - Hembra BSPT Fija 	D972-02-02	1/8	1/8	
	D972-02-04	1/8	1/4	
	D972-04-04	1/4	1/4	
	D972-04-06	1/4	3/8	
	D972-06-06	3/8	3/8	
	D972-06-08	3/8	1/2	
	D972-08-08	1/2	1/2	
	D972-08-12	1/2	3/4	
	D972-12-12	3/4	3/4	
	D972-16-16	1	1	

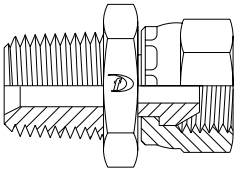
REFERENCIA	PARTE No.	BSPT T1	BSPP T2
<b>D980</b> Macho BSPT - Hembra BSPP "G" 	D980-02-02	1/8	1/8
	D980-04-04	1/4	1/4
	D980-06-06	3/8	3/8
	D980-06-08	3/8	1/2
	D980-08-06	1/2	3/8
	D980-08-08	1/2	1/2
	D980-08-12	1/2	3/4
	D980-12-12	3/4	3/4
	D980-12-16	3/4	1
	D980-16-12	1	3/4
	D980-16-16	1	1
	D980-20-20	1.1/4	1.1/4

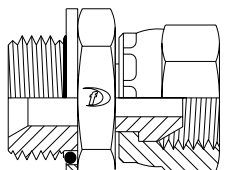
REFERENCIA	PARTE No.	BSPP O-RING T1	BSPP T2
<b>D943</b> Macho BSPP O-RING - Hembra BSPP "G" 	D943-02-02	1/8	1/8
	D943-04-04	1/4	1/4
	D943-06-06	3/8	3/8
	D943-06-08	3/8	1/2
	D943-08-06	1/2	3/8
	D943-08-08	1/2	1/2
	D943-12-12	3/4	3/4
	D943-16-16	1	1
	D943-20-20	1.1/4	1.1/4

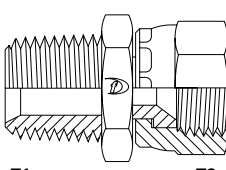
REFERENCIA	PARTE No.	BSPT T1	JIC T2	
<b>D961</b> Macho BSPT - Hembra JIC "G" 	D961-04-04	1/4	7/16	
	D961-04-06	1/4	9/16	
	D961-06-06	3/8	9/16	
	D961-06-08	3/8	3/4	
	D961-06-10	3/8	7/8	
	D961-08-08	1/2	3/4	
	D961-08-12	1/2	7/8	
	D961-12-17	3/4	1.1/16	
	D961-16-21	1	1.5/16	
	D961-24-26	1.1/2	1.5/8	

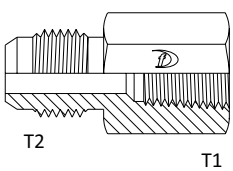
REFERENCIA	PARTE No.	BSPT T1	JIC T2
<b>D916</b> Macho JIC - Hembra BSPT Fija 	D916-02-04	1/8	7/16
	D916-02-06	1/8	9/16
	D916-04-06	1/4	9/16
	D916-06-08	3/8	3/4
	D916-08-06	1/2	9/16
	D916-08-08	1/2	3/4
	D916-08-10	1/2	7/8
	D916-08-12	1/2	1.1/16
	D916-12-12	3/4	1.1/16

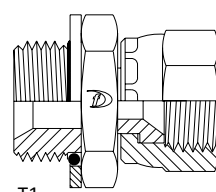
REFERENCIA	PARTE No.	BSPP O-RING T1	JIC T2
<b>D971</b> Macho BSPP O-RING - Hembra JIC "G" 	D971-04-06	1/4	9/16
	D971-06-06	3/8	9/16
	D971-06-08	3/8	3/4
	D971-06-10	3/8	7/8
	D971-08-05	1/2	1/2
	D971-08-08	1/2	3/4
	D971-08-10	1/2	7/8
	D971-12-06	3/4	9/16
	D971-12-08	3/4	3/4
	D971-12-10	3/4	7/8
	D971-12-12	3/4	1.1/16
	D971-16-12	1	1.1/16
	D971-16-16	1	1.5/16
	D971-20-20	1.1/4	1.5/16

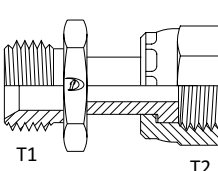
REFERENCIA	PARTE No.	BSPP O-RING T1	ORFS T2
<b>D9181</b> Macho BSPP O-RING - Hembra ORFS "G" 	D9181-04-06	1/4	11/16
	D9181-06-06	3/8	11/16
	D9181-06-08	3/8	13/16
	D9181-08-08	1/2	13/16

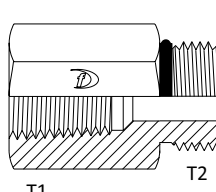
REFERENCIA	PARTE No.	BSPT T1	O-BOSS T2
<b>D996</b> Hembra BSPT - Macho O-RING BOSS "F" 	S96-04-06	1/4	9/16
	S96-06-08	3/8	3/4
	S96-08-08	1/2	3/4
	S96-08-10	1/2	7/8

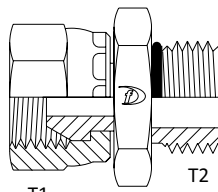
REFERENCIA	PARTE No.	BSPP T1	O-BOSS T2	
<b>D995</b> Hembra BSPP - Macho O-RING BOSS "G" 	D995-04-06	1/4	9/16	
	D995-06-08	3/8	3/4	
	D995-06-10	3/8	7/8	
	D995-08-08	1/2	3/4	
	D995-08-10	1/2	7/8	
	D995-12-10	3/4	7/8	
	D995-12-12	3/4	1.1/16	
	D995-16-16	1	1.5/16	

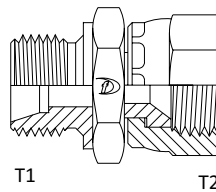
REFERENCIA	PARTE No.	DIN SL T1	JIC G T2
<b>D971ML</b> Macho DIN S.L. - Hembra JIC "G" 	D971ML-18-06	18x1,5	9/16

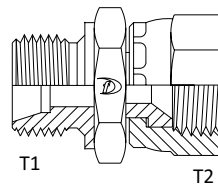
REFERENCIA	PARTE No.	DIN SP T1	JIC T2
<b>D971MS</b> Macho DIN S.P. - Hembra JIC "G" 	D971MS-18-04	18x1,5	7/16
	D971MS-18-06	18x1,5	9/16
	D971MS-24-08	24x1,5	3/4
	D971MS-30-12	30x2	1.1/16

REFERENCIA	PARTE No.	BSPT T1	BSPT T2
<b>D926</b> Unión Hembra BSPT	D926-02-02	1/8	1/8
	D926-04-04	1/4	1/4
	D926-06-04	3/8	1/4
	D926-06-06	3/8	3/8
	D926-08-04	1/2	1/4
	D926-08-06	1/2	3/8
	D926-08-08	1/2	1/2
	D926-12-04	3/4	1/4
	D926-12-08	3/4	1/2
	D926-12-12	3/4	3/4
	D926-16-12	1	3/4
	D926-16-16	1	1
	D926-20-20	1.1/4	1.1/4
	D926-24-24	1.1/2	1.1/2
D926-32-32	2	2	

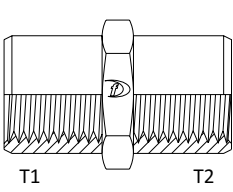

REFERENCIA	PARTE No.	BSPT T1	BSPP T2
<b>D981</b> Hembra BSPT - Hembra BSPP "G"	D981-04-04	1/4	1/4
	D981-06-06	3/8	3/8
	D981-08-06	1/2	3/8
	D981-08-08	1/2	1/2
	D981-12-12	3/4	3/4
	D981-16-16	1	1

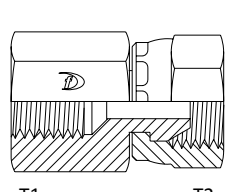

REFERENCIA	PARTE No.	BSPT T1	BSPT T2
<b>D945</b> Codo 45° Macho BSPT - Macho BSPT	D945-04-04	1/4	1/4
	D945-06-06	3/8	3/8
	D945-08-08	1/2	1/2
	D945-12-08	3/4	1/2
	D945-12-12	3/4	3/4
	D945-16-16	1	1

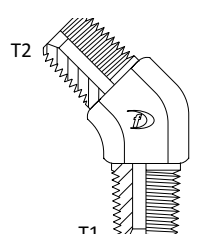

REFERENCIA	PARTE No.	BSPT T1	JIC T2
<b>D909</b> Codo 45° Macho BSPT - Macho JIC	D909-02-04	1/8	7/16
	D909-04-04	1/4	7/16
	D909-04-05	1/4	1/2
	D909-04-06	1/4	9/16
	D909-04-08	1/4	3/4
	D909-06-06	3/8	9/16
	D909-06-08	3/8	3/4
	D909-06-10	3/8	7/8
	D909-08-06	1/2	9/16
	D909-08-08	1/2	3/4
	D909-08-10	1/2	7/8
	D909-08-12	1/2	1.1/16
	D909-12-10	3/4	7/8
	D909-12-12	3/4	1.1/16
	D909-12-16	3/4	1.5/16
	D909-16-16	1	1.5/16
	D909-16-20	1	1.5/8
D909-20-20	1.1/4	1.5/8	
D909-24-24	1.1/2	1.7/8	

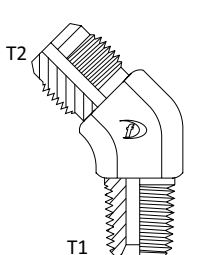

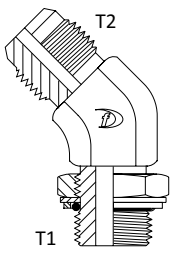
REFERENCIA	PARTE No.	BSPP O-RING T1	JIC T2
<b>D969</b> Codo 45° Macho BSPP O-RING - Macho JIC 	D969-04-09	1/4	7/16
	D969-08-09	1/2	9/16
	D969-08-12	1/2	3/4
	D969-08-14	1/2	7/8

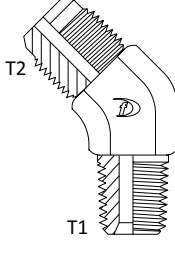
REFERENCIA	PARTE No.	BSPT T1	SAE T2	
<b>D990A</b> Codo 45° Macho BSPT - Macho SAE 	D990A-04-10	1/4	5/8	
	D990A-06-10	3/8	5/8	

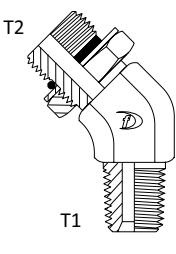
REFERENCIA	PARTE No.	BSPT T1	O-BOSS T2	
<b>D960</b> Codo 45° Macho BSPT - Macho O-RING BOSS 	D960-04-06	1/4	9/16	
	D960-06-08	3/8	3/4	
	D960-06-10	3/8	7/8	
	D960-08-08	1/2	3/4	
	D960-08-10	1/2	7/8	
	D960-08-12	1/2	7/8	
	D960-12-12	3/4	1.1/16	
	D960-16-16	1	1.5/16	

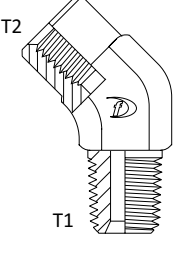
REFERENCIA	PARTE No.	BSPT T1	BSPT T2	
<b>D939</b> Codo 45° Macho BSPT - Hembra BSPT 	D939-04-04	1/4	1/4	
	D939-04-06	1/4	3/8	
	D939-06-06	3/8	3/8	
	D939-08-08	1/2	1/2	
	D939-12-12	3/4	3/4	

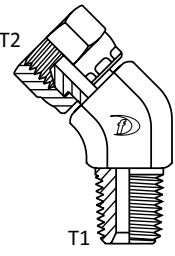
REFERENCIA	PARTE No.	BSPT T1	BSPP T2
<b>D984</b> Codo 45° Macho BSPT - Hembra BSPP "G" 	D984-04-04	1/4	1/4
	D984-06-06	3/8	3/8
	D984-08-06	1/2	3/8
	D984-08-08	1/2	1/2
	D984-12-12	1	1

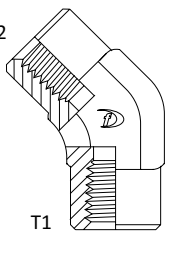
REFERENCIA	PARTE No.	BSPT T1	BSPT T2
<b>D931</b> Codo 45° Hembra BSPT - Hembra BSPT 	D931-02-02	1/8	1/8
	D931-04-04	1/4	1/4
	D931-06-06	3/8	3/8
	D931-08-08	1/2	1/2
	D931-12-12	3/4	3/4
	D931-16-16	1	1

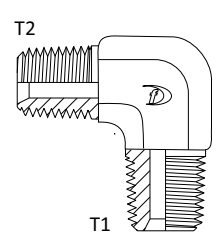
REFERENCIA	PARTE No.	BSPT T1	BSPT T2
<b>D949</b> Codo 90° Macho BSPT - Macho BSPT 	D949-02-02	1/8	1/8
	D949-04-02	1/4	1/8
	D949-04-04	1/4	1/4
	D949-06-04	3/8	1/4
	D949-06-06	3/8	3/8
	D949-08-04	1/2	1/4
	D949-08-06	1/2	3/8
	D949-08-08	1/2	1/2
	D949-12-08	3/4	1/2
	D949-12-12	3/4	3/4
	D949-16-12	1	3/4
	D949-16-16	1	1
	D949-20-12	1.1/4	3/4
	D949-20-16	1.1/4	1
	D949-20-20	1.1/4	1.1/4
	D949-24-24	1.1/2	1.1/2

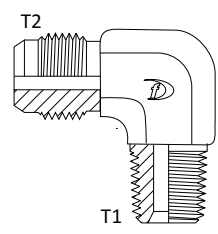
REFERENCIA	PARTE No.	BSPT T1	JIC T2
<b>D908</b> Codo 90° Macho BSPT - Macho JIC 	D908-02-04	1/8	7/16
	D908-02-05	1/8	1/2
	D908-02-06	1/8	9/16
	D908-04-04	1/4	7/16
	D908-04-05	1/4	1/2
	D908-04-06	1/4	9/16
	D908-04-08	1/4	3/4
	D908-06-04	3/8	7/16
	D908-06-05	3/8	1/2
	D908-06-06	3/8	9/16
	D908-06-08	3/8	3/4
	D908-06-10	3/8	7/8
	D908-08-05	1/2	7/16
	D908-08-06	1/2	9/16
	D908-08-08	1/2	3/4
	D908-08-10	1/2	7/8
	D908-08-12	1/2	1.1/16
	D908-10-10	5/8	7/8
	D908-12-06	3/4	9/16
	D908-12-08	3/4	3/4
	D908-12-10	3/4	7/8
	D908-12-12	3/4	1.1/16
	D908-12-14	3/4	1.3/16
	D908-12-16	3/4	1.5/16
	D908-16-12	1	1.1/16
	D908-16-16	1	1.5/16
	D908-16-20	1	1.5/8
	D908-20-16	1.1/4	1.5/16
	D908-20-20	1.1/4	1.5/8
	D908-24-24	1.1/2	1.7/8

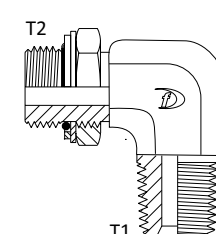
REFERENCIA	PARTE No.	BSPT T1	BSPP O-RING T2
<b>D977</b> Codo 90° Macho BSPT - Macho BSPP O-RING 	D977-04-04	1/4	1/4
	D977-04-06	1/4	3/8
	D977-06-06	3/8	3/8
	D977-06-08	3/8	1/2
	D977-08-08	1/2	1/2
	D977-08-12	1/2	3/4
	D977-12-12	3/4	3/4
	D977-12-16	3/4	1
	D977-16-16	1	1

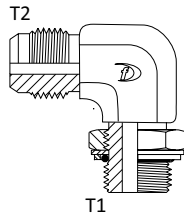
REFERENCIA	PARTE No.	BSPP O-RING T1	JIC T2
<b>D976</b> Codo 90° Macho BSPP O-RING - Macho JIC  	D976-02-04	1/8	7/16
	D976-04-04	1/4	7/16
	D976-04-05	1/4	1/2
	D976-04-06	1/4	9/16
	D976-04-08	1/4	3/4
	D976-06-04	3/8	7/16
	D976-06-06	3/8	9/16
	D976-06-08	3/8	3/4
	D976-06-10	3/8	7/8
	D976-08-05	1/2	1/2
	D976-08-06	1/2	9/16
	D976-08-08	1/2	3/4
	D976-08-10	1/2	7/8
	D976-08-12	1/2	1.1/16
	D976-12-06	3/4	9/16
	D976-12-08	3/4	3/4
	D976-12-10	3/4	7/8
	D976-12-12	3/4	1.1/16
	D976-12-16	3/4	1.5/16
	D976-16-12	1	1.1/16
D976-16-16	1	1.5/16	
D976-20-21	1.1/4	1.5/16	
D976-20-26	1.1/4	1.5/8	

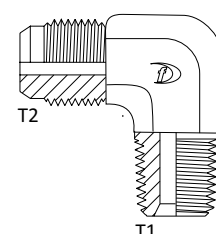
REFERENCIA	PARTE No.	BSPT T1	SAE T2	
<b>D908A</b> Codo 90° Macho BSPT - Macho SAE  	D908A-02-03	1/8	3/8	
	D908A-02-06	1/8	5/8	
	D908A-04-06	1/4	5/8	
	D908A-06-06	3/8	5/8	
	D908A-12-12	3/4	1.1/16	

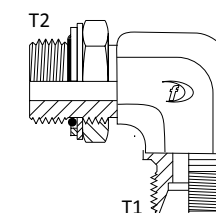
REFERENCIA	PARTE No.	DIN SL T1	BSPP O-RING T2
<b>D977ML</b> Codo 90° Macho DIN S.L. - Macho BSPP O-RING  	D977ML-18-04	18x1,5	1/4
	D977ML-18-06	18x1,5	3/8
	D977ML-18-08	18x1,5	1/2

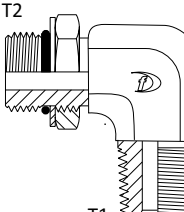
REFERENCIA	PARTE No.	BSPT T1	O-BOSS T2
<b>D989</b> Codo 90° Macho BSPT - Macho O-BOSS  	D989-04-06	1/4	9/16
	D989-04-08	1/4	3/4
	D989-06-06	3/8	9/16
	D989-06-08	3/8	3/4
	D989-06-10	3/8	7/8
	D989-08-08	1/2	3/4
	D989-08-10	1/2	7/8
	D989-08-12	1/2	1.1/16
	D989-12-08	3/4	3/4
	D989-12-10	3/4	7/8
	D989-12-12	3/4	1.1/16
	D989-16-16	1	1.5/16
	D989-16-20	1	1.5/8
	D989-20-20	1.1/4	1.5/8

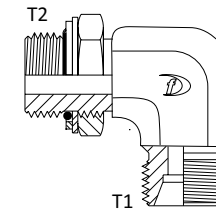
REFERENCIA	PARTE No.	DIN SL T1	BSPP O-RING T2
<b>D977MS</b> Codo 90° Macho DIN S.P. - Macho BSPP O-RING  	D977MS-18-04	18x1,5	1/4
	D977MS-24-08	24x1,5	1/2
	D977MS-30-08	30x2,0	1/2
	D977MS-36-12	36x2,0	3/4
	D977MS-42-12	42x2,0	3/4

REFERENCIA	PARTE No.	BSPT T1	BSPP T2
<b>D982</b> Codo 90° Macho BSPT - Hembra BSPP "G"	D982-02-02	1/8	1/8
	D982-04-04	1/4	1/4
	D982-06-06	3/8	3/8
	D982-08-06	1/2	3/8
	D982-08-08	1/2	1/2
	D982-08-12	1/2	3/4
	D982-12-12	3/4	3/4
	D982-12-16	3/4	1
	D982-16-12	1	3/4
	D982-16-16	1	1

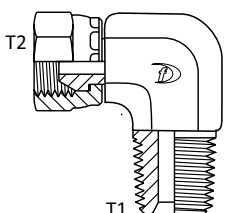

REFERENCIA	PARTE No.	BSPP O-RING T1	BSPP T2
<b>D9105</b> Codo 90° Macho BSPP O-RING - Hembra BSPP "G"	D9105-04-04	1/4	1/4
	D9105-06-06	3/8	3/8
	D9105-08-06	1/2	3/8
	D9105-08-08	1/2	1/2
	D9105-08-12	1/2	3/4
	D9105-12-08	3/4	1/2
	D9105-12-12	3/4	3/4
	D9105-12-16	3/4	1
	D9105-16-16	1	1
	D9105-20-20	1.1/4	1.1/4

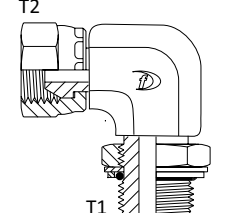

REFERENCIA	PARTE No.	BSPP T1	O-BOSS T2
<b>D994</b> Codo 90° Hembra BSPP "G" - Macho O-BOSS	D994-02-04	1/4	7/16
	D994-04-06	1/4	9/16
	D994-06-08	3/8	3/4
	D994-08-08	1/2	3/4
	D994-08-10	1/2	7/8
	D994-12-12	3/4	1.1/16
	D994-16-16	1	1.5/16
	D994-20-20	1.1/4	1.5/8

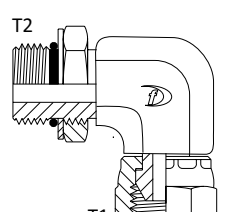

REFERENCIA	PARTE No.	BSPT T1	BSPT T2
<b>D928</b> Codo 90° Hembra BSPT - Hembra BSPT "F"	D928-02-02	1/8	1/8
	D928-04-04	1/4	1/4
	D928-06-06	3/8	3/8
	D928-08-08	1/2	1/2
	D928-12-12	3/4	3/4
	D928-16-16	1	1
	D928-20-20	1.1/4	1.1/4

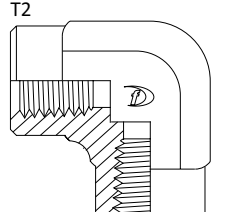

REFERENCIA	PARTE No.	BSPT T1	BSPT T2	BSPT T3
<b>D950</b> Tee Macho BSPT	D950-02-02-02	1/8	1/8	1/8
	D950-04-04-04	1/4	1/4	1/4
	D950-06-06-06	3/8	3/8	3/8
	D950-06-06-08	3/8	3/8	1/2
	D950-08-08-08	1/2	1/2	1/2
	D950-08-08-12	1/2	1/2	3/4
	D950-12-08-12	3/4	1/2	3/4
	D950-12-12-08	3/4	3/4	1/2
	D950-12-12-12	3/4	3/4	3/4
	D950-16-12-16	1	3/4	1
	D950-16-16-16	1	1	1
	D950-20-20-20	1.1/4	1.1/4	1.1/4

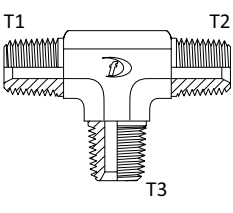

REFERENCIA	PARTE No.	BSPT T1	BSPP O-RING T2	BSPT T3
<b>D9104</b> Tee Macho BSPT - Macho BSPP O-RING - Macho BSPT	D9104-04-04-04	1/4	1/4	1/4
	D9104-04-06-04	1/4	3/8	1/4
	D9104-06-06-06	3/8	3/8	3/8
	D9104-08-08-08	1/2	1/2	1/2
	D9104-12-12-12	3/4	3/4	3/4
	D9104-16-16-16	1	1	1
	D9104-20-20-20	1.1/4	1.1/4	1.1/4

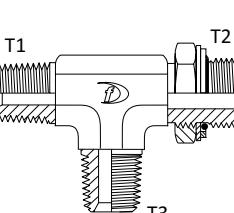

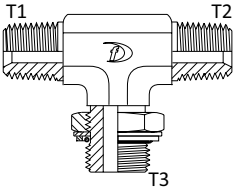

REFERENCIA	PARTE No.	BSPT T1	BSPT T2	BSPP O-RING T3
<b>D9135</b> Tee Macho BSPT - Macho BSPT - Macho BSPP O-RING	D9135-06-06-06	3/8	3/8	3/8
				

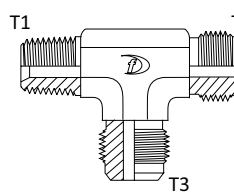
REFERENCIA	PARTE No.	BSPT T1	JIC T2	JIC T3
<b>D921</b> Tee Macho BSPT - Macho JIC - Macho JIC	D921-02-04-04	1/8	7/16	7/16
	D921-04-04-04	1/4	7/16	7/16
	D921-04-06-06	1/4	9/16	9/16
	D921-06-06-06	3/8	9/16	9/16
	D921-06-06-08	3/8	9/16	3/4
	D921-06-08-08	3/8	3/4	3/4
	D921-08-08-08	1/2	3/4	3/4
	D921-08-10-10	1/2	7/8	7/8
	D921-08-12-12	1/2	1.1/16	1.1/16
	D921-12-12-12	3/4	1.1/16	1.1/16
	D921-16-12-12	1	1.1/16	1.1/16
	D921-16-16-16	1	1.5/16	1.5/16
				

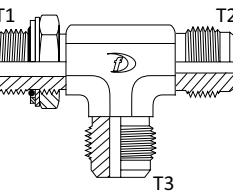
REFERENCIA	PARTE No.	BSPP O-RING T1	JIC T2	JIC T3
<b>D978</b> Tee Macho BSPP O-RING - Macho JIC - Macho JIC	D978-04-04-04	1/4	7/16	7/16
	D978-04-06-06	1/4	9/16	9/16
	D978-04-08-08	1/4	3/4	3/4
	D978-06-06-06	3/8	9/16	9/16
	D978-06-08-08	3/8	3/4	3/4
	D978-08-08-08	1/2	3/4	3/4
	D978-08-10-10	1/2	7/8	7/8
	D978-08-12-12	1/2	1.1/16	1.1/16
	D978-12-08-08	3/4	3/4	3/4
	D978-12-12-12	3/4	1.1/16	1.1/16
	D978-16-16-16	1	1.5/16	1.5/16
	D978-20-16-16	1.1/4	1.5/16	1.5/16
	D978-20-20-20	1.1/4	1.5/8	1.5/8
				

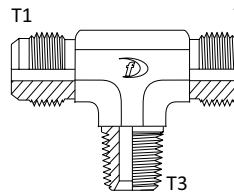
REFERENCIA	PARTE No.	JIC T1	JIC T2	BSPT T3
<b>D920</b> Tee Macho JIC - Macho JIC - Macho BSPT	D920-04-04-02	7/16	7/16	1/8
	D920-04-04-04	7/16	7/16	1/4
	D920-05-05-04	1/2	1/2	1/4
	D920-05-05-08	1/2	1/2	1/2
	D920-06-06-04	9/16	9/16	1/4
	D920-08-08-06	3/4	3/4	3/8
	D920-08-08-08	3/4	3/4	1/2
	D920-08-12-08	3/4	1.1/16	1/2
	D920-10-10-06	7/8	7/8	3/8
	D920-10-10-08	7/8	7/8	1/2
	D920-12-12-12	1.1/16	1.1/16	3/4
	D920-12-12-16	1.1/16	1.1/16	1
	D920-16-16-12	1.5/16	1.5/16	3/4
	D920-20-20-20	1.5/8	1.5/8	1.1/4
				

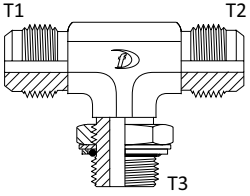
REFERENCIA	PARTE No.	JIC T1	JIC T2	BSPP O-RING T3
<b>D979</b> Tee Macho JIC - Macho JIC - Macho BSPP O-RING 	D979-04-04-04	7/16	7/16	1/4
	D979-06-06-04	9/16	9/16	1/4
	D979-06-06-06	9/16	9/16	3/8
	D979-08-08-06	3/4	3/4	3/8
	D979-08-08-08	3/4	3/4	1/2
	D979-10-10-08	7/8	7/8	1/2
	D979-10-10-12	7/8	7/8	3/4
	D979-12-12-12	1.1/16	1.1/16	3/4
	D979-16-16-12	1.5/16	1.5/16	3/4
	D979-16-16-16	1.5/16	1.5/16	1
	D979-20-20-20	1.5/8	1.5/8	1.1/4

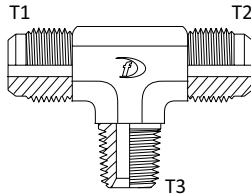
REFERENCIA	PARTE No.	SAE T1	SAE T2	BSPT T3
<b>D920A</b> Tee Macho SAE - Macho SAE - Macho BSPT 	D920A-08-08-06	3/4	3/4	3/8

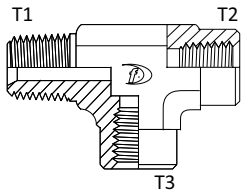
REFERENCIA	PARTE No.	BSPT T1	BSPT F T2	BSPT F T3
<b>D948</b> Tee Macho BSPT - Hembra BSPT "F" - Hembra BSPT "F" 	D948-02-02-02	1/8	1/8	1/8
	D948-04-04-04	1/4	1/4	1/4
	D948-06-06-06	3/8	3/8	3/8
	D948-08-08-08	1/2	1/2	1/2
	D948-12-12-12	3/4	3/4	3/4
	D948-16-16-16	1	1	1

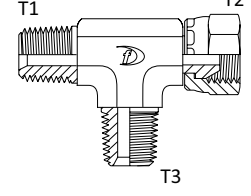
REFERENCIA	PARTE No.	BSPT T1	BSPP T2	BSPT T3	
<b>D9167</b> Tee Macho BSPT - Hembra BSPP "G" - Macho BSPT 	D9167-04-04-04	1/4	1/4	1/4	
	D9167-06-06-06	3/8	3/8	3/8	
	D9167-08-08-08	1/2	1/2	1/2	
	D9167-12-12-12	3/4	3/4	3/4	
	D9167-16-16-16	1	1	1	

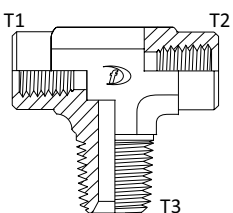
REFERENCIA	PARTE No.	BSPT T1	BSPT T2	BSPT T3
<b>D947</b> Tee Hembra BSPT "F" - Hembra BSPT "F" - Macho BSPT	D947-08-08-08	1/2	1/2	1/2
	D947-12-12-12	3/4	3/4	3/4
				

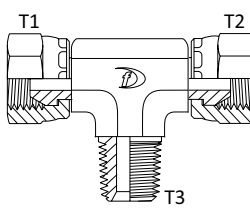
REFERENCIA	PARTE No.	BSPP T1	BSPP T2	BSPT T3
<b>D983</b> Tee Hembra BSPP "G" - Hembra BSPP "G" - Macho BSPT	D983-04-04-04	1/4	1/4	1/4
	D983-06-06-06	3/8	1/4	3/8
	D983-08-08-08	1/2	1/2	1/2
	D983-12-12-12	3/4	3/4	3/4
	D983-16-16-16	1	1	1
				

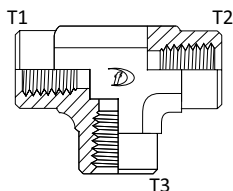
REFERENCIA	PARTE No.	BSPT T1	BSPT T2	BSPT T3
<b>D929</b> Tee Hembra BSPT "F" - Hembra BSPT "F" - Hembra BSPT "F"	D929-02-02-02	1/8	1/8	1/8
	D929-04-04-04	1/4	1/4	1/4
	D929-06-06-06	3/8	3/8	1/4
	D929-08-08-08	1/2	1/2	1/2
	D929-12-12-12	3/4	3/4	3/4
	D929-16-16-16	1	1	1
	D929-20-20-20	1.1/4	1.1/4	1.1/4
	D929-32-32-32	2	2	2
				

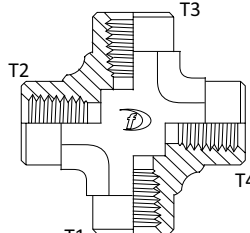
REFERENCIA	PARTE No.	BSPT T1	BSPT T2	BSPT T3
<b>D932</b> Cruz Hembra BSPT Fija	D932-04-04-04-04	1/4	1/4	1/4
	D932-06-06-06-06	3/8	1/4	3/8
	D932-08-08-08-08	1/2	1/2	1/2
	D932-12-12-12-12	3/4	3/4	3/4
	D932-16-16-16-16	1	1	1
				

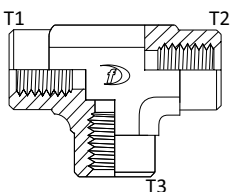
REFERENCIA	PARTE No.	BSPP T1	BSPP T2	BSPP T3
<b>D9139</b> Tee Hembra BSPP "F" - Hembra BSPP "F" - Hembra BSPP "F"	D9139-32-32-32	2	2	2
				

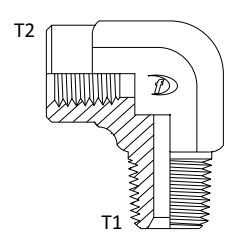
REFERENCIA	PARTE No.	BSPT T1	BSPT T2	
<b>D925</b> Codo 90° Macho BSPT - Hembra BSPT "F"	D925-02-02	1/8	1/8	
	D925-04-04	1/4	1/4	
	D925-06-04	3/8	1/4	
	D925-06-06	3/8	3/8	
	D925-06-08	3/8	1/2	
	D925-08-06	1/2	3/8	
	D925-08-08	1/2	1/2	
	D925-08-12	1/2	3/4	
	D925-12-12	3/4	3/4	
	D925-16-16	1	1	
	D925-20-20	1.1/4	1.1/4	
				

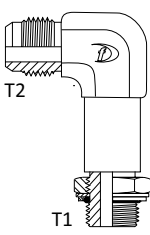
REFERENCIA	PARTE No.	BSPP O-RING T1	JIC T2
<b>D970</b> Codo 90° Macho BSPP O-RING - Macho JIC Largo 	D970-06-06	3/8	9/16
	D970-06-08	3/8	3/4
	D970-08-08	1/2	3/4
	D970-08-10	1/2	7/8
	D970-12-12	3/4	1.1/16
	D970-16-16	1	1.5/16

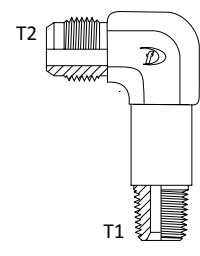
REFERENCIA	PARTE No.	BSPT T1	JIC T2
<b>D911</b> Codo 90° Macho BSPT - Macho JIC Largo 	D911-02-04	1/8	7/16
	D911-08-10	1/2	7/8